

Technical manual

X-am® 3500/8000



HFG 000* / HFG 001*

This page has been left blank intentionally.

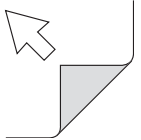

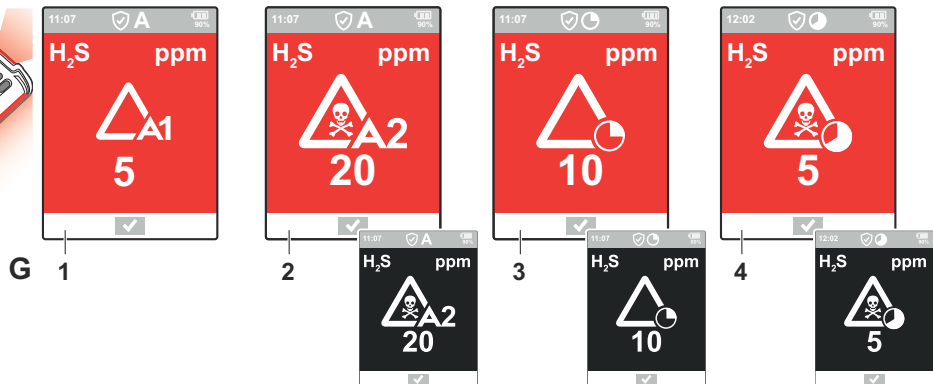
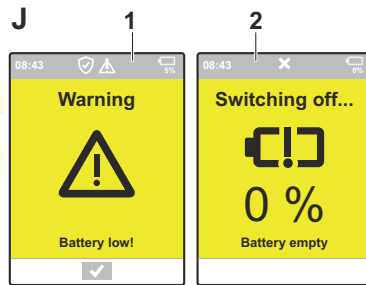
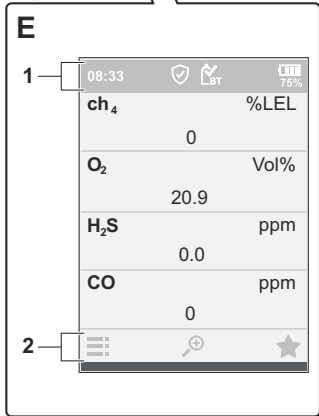
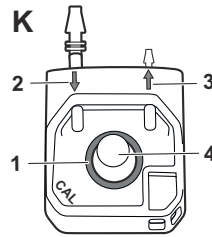
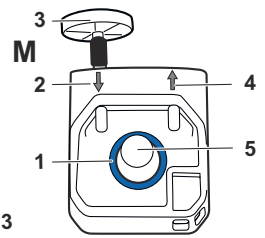
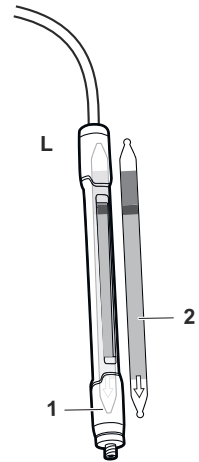
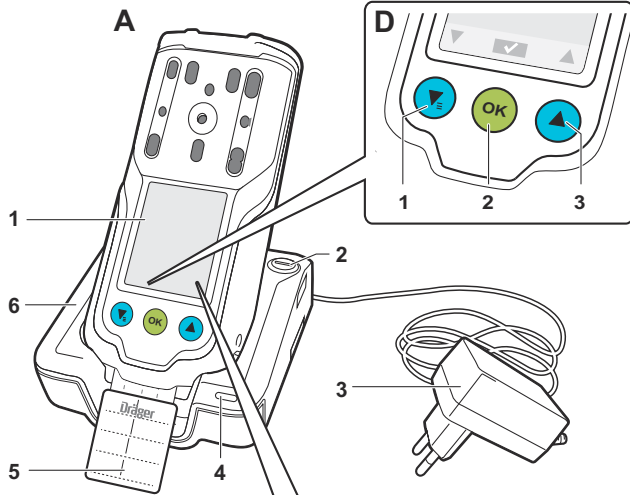
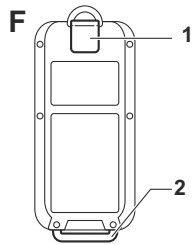
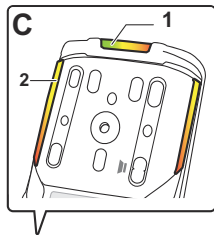
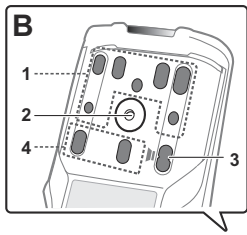

Contents

1	Safety-related information	8
1.1	Information on safety notes and warnings	8
1.1.1	Safety notes.....	8
1.1.2	Warnings	8
1.2	Basic safety information.....	8
1.3	Use in areas subject to explosion hazards	8
2	Conventions in this document	10
2.1	Meaning of the warning notes.....	10
2.2	Trade marks.....	10
2.3	Typographical conventions	10
2.4	Glossary.....	10
2.5	Abbreviations	11
3	Description	13
3.1	Product overview	13
3.2	Intended use	14
3.3	Limitations on use.....	14
3.4	Approvals.....	14
3.5	Label.....	14
3.6	Sensor slot positions X-am 3500	14
3.7	Sensor slot positions X-am 8000	15
3.8	Further device options for X-am 8000	15
4	Operation	16
4.1	Operating concept	16
4.2	Symbol explanations.....	16
4.2.1	feature buttons.....	16
4.2.2	Displays	16
4.2.3	Application.....	16
4.2.4	Device status	17
4.2.5	Connection	17
4.2.6	User level.....	17
4.2.7	Display in gas channel.....	17
4.3	Signalling concept.....	18
4.3.1	Acoustic operation signal.....	18
4.3.2	Visual operation signal	18
4.3.3	Visual operation signal with activated D-Light.....	18
4.4	Switch the gas detector on or off	18
4.4.1	Initial start-up	18
4.4.2	Switching on the gas detector	19
4.4.3	Switching off the gas detector	19
4.5	Logging a user in or out	20
4.6	Preparations for operation	21
4.7	During operation	21
4.7.1	Monitoring measuring mode	22
4.7.2	Alarms	23
4.7.3	Special state	23

4.7.4	Blocking alarm	23
4.7.5	Deleting (application) peaks	24
4.8	Calling the Quick Menu.....	24
4.9	Opening information	24
4.10	Measuring	25
4.10.1	Special features when measuring with the pump	25
4.10.2	Carrying out measuring with the pump	26
4.11	Measurements with wizards	28
4.12	Carrying out confined space entry measurements with the wizard	28
4.13	Carrying out leak searches with the wizard	29
4.14	Carrying out a benzene/pre-tube measurement with the wizard	30
4.14.1	Mounting the pre-tube bracket.....	30
4.14.2	Making measurement.....	32
4.15	Configuring the device settings.....	33
4.15.1	Activating day or night mode	33
4.15.2	Changing the device language	33
4.15.3	Setting the date and time.....	33
4.15.4	Activating silent mode.....	33
4.15.5	Activating or deactivating the capture range	33
4.15.6	Activating or deactivating Bluetooth® (X-am 8000 only)...	34
4.16	Activating an automatic over range	34
4.17	Hydrogen (H ₂) added signal (for IR Ex).....	34
5	Troubleshooting.....	36
5.1	Error.....	36
5.2	Warnings.....	37
6	Maintenance	39
6.1	Maintenance intervals.....	39
6.2	Calibration intervals	39
6.3	Perform bump test	40
6.3.1	Carrying out bump tests with the wizard.....	40
6.4	Calibrate the gas detector.....	42
6.4.1	Carrying out a fresh air calibration.....	42
6.4.2	Carrying out a single-gas calibration	43
6.4.3	Carrying out a multi-gas calibration	45
6.4.4	Carrying out a cross calibration	47
6.5	Carrying out a signal test	47
6.6	Charging the battery	47
6.7	Exchanging, adding or removing a sensor	48
6.8	Cleaning the PID lamp (X-am 8000 only)	52
6.9	Exchange the device components.....	53
6.9.1	Opening the gas detector	53
6.9.2	Blind bracket / strap retainer / labelling field/label for strap	55
6.9.3	Battery	55
6.9.4	RFID transponder.....	56
6.9.5	Front housing cradle with diaphragms.....	56
6.9.6	Vibration motor	56
6.9.7	Sensor sealing plate	57
6.9.8	Sensor holders	58
6.9.9	Pump block.....	58
6.9.10	Horn / resonator.....	60

6.10	Labelling field/label for strap	61
6.11	Mounting the clip.....	61
6.12	Radio-Frequency Identification (RFID)	61
6.13	Cleaning.....	62
7	Configuration	63
7.1	Standard gas configuration.....	63
7.2	Configuring the gas detector.....	65
7.2.1	Configuring the gas detector with the Dräger X-dock and reading the data memory	65
7.2.2	Configuring the gas detector with the PC and reading the data memory	66
8	Device settings.....	67
8.1	Factory settings	67
8.2	Device and sensor settings.....	68
8.3	Alarm settings	69
9	Transport	70
10	Storage.....	71
11	Disposal	72
12	Technical data	73
12.1	Gas detector	73

1 Safety-related information

1.1 Information on safety notes and warnings

Safety notes and warnings warn of dangers and provide instructions for the safe use of the product. Failure to observe these safety notes and warnings may result in personal injury or damage to property.

1.1.1 Safety notes

This document contains sections with safety notes which warn of dangers. The type of danger and the consequences following failure to observe the safety note are included in every safety note.

1.1.2 Warnings

Warnings refer to steps of a task and warn of dangers which may result while the steps are executed. Warnings appear before the steps.

1.2 Basic safety information

- Before using this product, carefully read the associated instructions for use. This document does not replace the instructions for use.

1.3 Use in areas subject to explosion hazards

To reduce the risk of ignition of a flammable or explosive atmosphere, strictly observe the following safety notes:

Use in areas subject to explosion hazards

Devices or components for use in explosion-hazard areas which have been tested and approved according to national, European or international explosion protection regulations may only be used under the conditions specified in the approval and with consideration of the relevant legal regulations. The devices or components may not be modified in any manner. The use of faulty or incomplete parts is forbidden. The appropriate regulations must be observed at all times when carrying out repairs on these devices or components.

i X-am 8000: Increased hydrogen concentrations within the measuring range of the DrägerSensor XXS H₂ HC may result in false alarms due to the additive effect on the DrägerSensors XXS H₂S and XXS CO, XXS H₂S-LC and XXS CO-LC as well as due to the negative effect on the DrägerSensor XXS O₂.

Oxygen-enriched atmospheres

Explosion protection is not guaranteed in oxygen-enriched atmospheres (>21 vol. % O₂).

- ▶ Remove the device from the potentially explosive atmosphere.

Oxygen deficient atmospheres

Measurements in oxygen deficient atmospheres (<12 vol. % O₂) may return incorrect displays on the CatEx sensor. In this case the CatEx sensor cannot provide a reliable measurement.

- ▶ Remove the device from the area.

The CatEx sensor in oxygen deficient or oxygen enriched environments

Incorrect measured values may be displayed in an oxygen deficient or oxygen enriched environment.

- ▶ The CatEx sensor is intended to measure flammable gasses and vapours mixed with air (i.e. O₂ content ≈ 21 vol. %). If the O₂ content falls below 12 vol. % and an operational O₂ sensor is available, a channel error is triggered on the CatEx channel due to oxygen deficiency.

Incorrect calibration

CAUTION: An incorrect calibration leads to incorrect measured values.

- ▶ CSA requirement (Canadian Standard Association): The sensitivity must be checked daily before first using the device with a known concentration of the gas to be measured that corresponds to 25 to 50 % of the final concentration. The accuracy must amount to 0 to +20 % of the actual value. The accuracy can be corrected by calibration.

RFID tag (optional)

- ▶ The RFID tag must not be read out in explosion-hazard areas.

NOTICE**Damage to the CatEx sensor!**

Fractions of catalytic poisons in the measuring gas (e.g. volatile silicon, sulphur, heavy metal compounds or halogenated hydrocarbon) can damage the Cat Ex sensor.

- ▶ If the CatEx sensor can no longer be calibrated to the target concentration, replace the sensor.



DrägerSensor CatEx 125 PR (6812950) and CatEx 125 PR Gas (6813080)

- ▶ For this gas detector, only use sensors with serial numbers > ARLB XXXX (starting with date of manufacture in February 2018). These sensors are certified for use in zone 0, T4.

2 Conventions in this document

2.1 Meaning of the warning notes

The following alert icons are used in this document to provide and highlight areas of the associated text that require a greater awareness by the user. A definition of the meaning of each icon is as follows:

Alert icon	Signal word	Consequences in case of nonobservance
	WARNING	Indicates a potentially hazardous situation which, if not avoided, may result in death or serious injury.
	CAUTION	Indicates a potentially hazardous situation which, if not avoided, may result in injury. It may also be used to alert against unsafe practices.
	NOTICE	Indicates a potentially hazardous situation which, if not avoided, could result in damage to the product or environment.

2.2 Trade marks

Brand	Brand owner
X-am®	Dräger
Bluetooth®	Bluetooth SIG, Inc.

The brands listed are only registered in certain countries and not necessarily in the country in which this material is sold.

2.3 Typographical conventions

Text	Text in bold identifies labels on the device and text on the display.
▶	This triangle in warnings identifies the options available for avoiding the hazard.
>	The greater-than symbol identifies a navigation path in a menu.
	This symbol indicates information that may make the use of this product easier.

2.4 Glossary

Term	Description
Operation signal	A periodic optical (green LED) and/or acoustic signal.
Measurement mode	Measurement in one of the applications (monitoring, confined space entry, leak search, benzene/pre-tube measurement) (X-am 8000 only).

Term	Description
Monitoring	Monitoring without pump (diffusion) Monitoring with pump (with pump adapter)
Capture range	The capture range refers to a measured value range within which minor variations in measured values (such as signal noise, variations in concentration) do not cause variations in the display. Measured values outside the capture range will be displayed with the actual measured value.
Confined space entry wizard	Measurement with pump and any accessories (e.g. hose, probe) for clearance measurements of specific areas (X-am 8000 only).
Leak search wizard	Leak search measurement (X-am 8000 only)
Benzene/pre-tube wizard	Benzene/pre-tube measurement (X-am 8000 only)
Peak	Peak value
Quick bump test	Test for alarm triggering.
Extended bump test	Test for accuracy and alarm triggering.
Special state	If a special state is signalled, the user is not warned of gas concentrations which may be dangerous. The following device features are special states: First set-up / configuration with the PC menu, preparation phase of the wizards, maintenance wizard bump test and calibration, warm-up 1 of the sensors.
D-Light	The D-Light feature allows the user to check and indicate compliance with certain settings.
Physical sensors	The CatEx, IR, and PID sensor types are designated as physical sensors. There are also the electrochemical sensors.

2.5

Abbreviations

Abbreviation	Explanation
A1	Pre-alarm
A2	Main alarm
CSE	Confined space entry, clearance measurement (before entering confined spaces)
FKM	Fluoroelastomer
IR	Infrared
PID	Photoionization detector
PTFE	Polytetrafluoroethylene
PVC	Polyvinyl chloride
STA	Short time average, average value over a short period of time (generally 15 minutes).
STEL	Short time exposure limit, threshold of an exposition over a short period of time (generally 15 minutes).

Abbreviation	Explanation
STEV	Short time exposure value, average value of exposure over a short period of time (generally 15 minutes).
TWA	Time weighted average, average shift values are generally limited to eight hours exposure per day per workplace for 5 days a week during a work lifetime. Observe the national definition of the occupational exposure limit.

3 Description

3.1 Product overview

The graphics are displayed on the fold-out page.

Graphic A

1	Display	4	Charge LED green/red
2	Locking screw for an additional charging module	5	Labelling field (X-am 8000 only)
3	Power supply unit	6	Induction charger

Graphic B

1	Gas inlets	3	Horn
2	Thread port for pumps and calibration adapter	4	Pump outlet and inlet

Graphic C

1	LED green/yellow/red	2	LED yellow/red
---	----------------------	---	----------------

Graphic D

1	feature button 1	3	feature button 3
2	feature button 2		

Graphic E

1	Status information	2	Navigation bar
---	--------------------	---	----------------

Graphic F

1	Clip (optional)	2	Socket for support belt for shoulder version (X-am 8000 only)
---	-----------------	---	---

Graphic G

1	Alarm A1	3	STEL alarm
2	Alarm A2	4	TWA alarm

Graphic J

1	Battery pre-alarm	2	Battery main alarm
---	-------------------	---	--------------------

Graphic K

1	Calibration adapter (grey coloured ring)	3	Exhaust
2	Gas inlet	4	Locking screw

Graphic L

1	Pre-tube bracket (X-am 8000 only)	2	Pre-tube (X-am 8000 only)
---	-----------------------------------	---	---------------------------

Graphic M

1	Pump adapter (blue coloured ring)	4	Exhaust
2	Gas inlet	5	Locking screw
3	Dust and water filter		

3.2 Intended use

Dräger X-am 3500/8000 is a portable gas detector for clearance measurements and for the continuous monitoring of the concentration of several gases in ambient air in the workplace and in explosion-hazard areas.

The X-am 3500 allows measuring up to 4 gases in accordance with the DrägerSensors (XXS O₂, XXS H₂S LC, XXS CO LC, XXS NO₂, XXS SO₂ and CatEx 125 PR) which are installed. The gas detector can be operated in pump mode or in diffusion mode.

X-am 8000 can measure up to 7 gasses in accordance with the installed DrägerSensors (EC, IR, CatEx, PID). The gas detector can be operated in pump mode (if it is equipped with a pump) or in diffusion mode.

3.3 Limitations on use

The gas detector is not suitable for measuring process gasses.

Operation of the gas detector in the charging cradle in a vehicle is only permitted under the following conditions:

- Acoustic signalling must be deactivated (with the help of the PC software CC-Vision).

3.4 Approvals

A copy of the rating plate and the declaration of conformity are provided in the enclosed supplementary documentation (order no. 90 33 655).

CSA-specific information:

Only the combustible gas portion of this instrument has been tested for measuring accuracy.

Radio approval (X-am 8000 only):

The information for radio approval can be viewed in the menu. For further information, see the following chapter: "Opening information", page 24.

3.5 Label

The energy supply label has a mark for a service label. Here, a maximum of one service label and one year-point label may be attached one on top of the other. Further labels, conductive labels or labels with conductive material or parts can have a negative effect on inductive charging.

 The rating plate on the gas detector must not be concealed.

3.6 Sensor slot positions X-am 3500

Sensor slot	Configuration
HPP 1	not assigned
HPP 2	CatEx sensor
EC 1-3	EC sensors

3.7 Sensor slot positions X-am 8000

Sensor slot	Configuration
HPP 1	PID or IR sensor
HPP 2	IR or CatEx sensor
EC 1-3	EC sensors

3.8 Further device options for X-am 8000

The following device options are available if needed:

- Pump
- RFID transponder
- Bluetooth® module
- Carrying clip













4 Operation

4.1 Operating concept

Navigation is done with the 3 multifeature buttons and the dynamic navigation bar (see Graphic E on the fold-out page). The navigation bar changes dynamically depending on the available interactions.

4.2 Symbol explanations







4.2.1 feature buttons

Symbol	Explanation
	Confirm action/dialog / return to menu
	Confirm all
	Scroll up / through display
	Scroll down / through display
	Cancel action
	Display quick menu
	Display measuring channels individually
	Display all measuring channels
	Increase value
	Decrease value
	Repeat feature
	Display menu







4.2.2 Displays

Symbol	Explanation
	Horn and vibration for gas alarm deactivated





4.2.3 Application

Symbol	Explanation
	Messen
	Clearance measurement (X-am 8000 only)
	Leak search (X-am 8000 only)
	Benzene/pre-tube measurement (X-am 8000 only)
	Fresh air adjustment
	Bump test or calibration



4.2.4 Device status

Symbol	Explanation
	Overview of the bump test intervals activated (additional information for the D-Light feature). There are no gas alarms or errors.
	Monitoring of the calibration intervals activated, D-Light function deactivated (additional information for the D-Light function). There are no gas alarms or errors.
A	Alarm message
	Warning message The gas detector can be operated normally. If the warning message is still displayed after operation, the gas detector requires maintenance. Menu Messages displays details.
X	Fault message The gas detector or measuring channel is not ready to measure and requires maintenance. Menu Messages displays details.
	Information message Menu Messages displays details.
	STEL alarm message
	TWA alarm message
	Event report



4.2.5 Connection

Symbol	Explanation
	Maintenance mode (access to the device via PC or X-dock)
	Bluetooth® activated
	Bluetooth® deactivated
	Bluetooth® connection established

4.2.6 User level

Symbol	Explanation
	User level 1
	User level 2
	User level 3

4.2.7 Display in gas channel

Symbol	Explanation
	Bump test or calibration successful
	Bump test or calibration failed
	Measurement range exceeded

Symbol	Explanation
↓↓↓	Readings below the measurement range
--	Channel error
!-!	Blocking alarm
#####	Value too high to be displayed

4.3 Signalling concept

4.3.1 Acoustic operation signal

A periodic acoustic signal indicates that the device is functional. The acoustic operation signal can be deactivated. For further information, see the following chapter: "Activating silent mode", page 33

4.3.2 Visual operation signal

A periodic pulse (increasing and decreasing intensity) of the green LED indicates:

- Monitoring, confined space entry, leak search or benzene/pre-tube measurement application active
- There is no device or channel error, no gas alarm and no special state

4.3.3 Visual operation signal with activated D-Light

An activated D-Light feature allows the user to also check and indicate compliance with certain settings:

- Evaluation of bump test intervals activated and complied with (factory setting) or evaluation of the calibration intervals active and complied with
- Usage interval complied with

The D-Light feature can be activated using the Dräger CC-Vision PC software.

Signalling visually corresponds to the operating signal.

If one of the conditions listed is not fulfilled and the D-Light is activated, the green LED will switch on briefly at regular intervals (short flash approx. every 60 s) instead of pulsing periodically.

4.4 Switch the gas detector on or off

4.4.1 Initial start-up

When the gas detector is switched on for the first time, a wizard starts. The wizard guides the user through the set-up of the gas detector:

- Language selection, if applicable
- Data format and date
- Time

4.4.2 Switching on the gas detector

1. Hold down the **OK** button for approx. 3 s.
 - ⇒ The display shows a countdown.
 - ⇒ The switch-on sequence and the warm-up phase of the sensors start.

The following display appear one after the other:

- Start screen
- Software version
- Display test (the display alternates between black and white)
- Alarm element test (LEDs, alarm signal and vibration alarm)
- Customer-specific information screen (optional)
- Alarm thresholds, STEL, TWA (if configured) and LEL factor (if available)
- Any expired bump test or calibration interval as well as early warnings (if configured)
- Measured value display

After the wizard is complete, a customer-specific information screen (optional and configurable with the Dräger CC-Vision PC software) and the measured value display appear. The remaining sensor warm-up time is displayed in the upper, left-hand corner in a yellow box.

WARNING

Incorrect device feature/settings!

Incorrect device features/settings may result in danger to life and/or risk of explosion.

- ▶ Before every use, check whether the display elements, the alarm features and information are displayed correctly. If one of the items listed above does not feature correctly or is incorrect, do not use the gas detector and have it inspected.

The following features are active during the sensor warm-up phase:

- The measured values flash
 - The yellow LED is illuminated
 - A warning notice is displayed
- ⇒ The gas detector is ready to measure when the measured values no longer flash and the yellow LED is no longer illuminated. The warning notice may continue to be displayed if there are warnings pending. To display the warnings, refer to the technical manual.

 No alarms are issued during the warm-up phase!

4.4.3 Switching off the gas detector

1. Hold down **▲** and **▼** simultaneously until the displayed countdown expires.
 - ⇒ The visual, acoustic and vibration alarms activate briefly.
 - ⇒ The gas detector is switched off.

Or

1. Select  in measuring mode and confirm the dialog.

2. Select and confirm **Switch off**.

 The gas detector may only be switched off without a prior sign-on if the **Switch-off allowed** feature is activated using the Dräger CC-Vision PC software. Factory setting: activated

 When the gas detector is placed in the charging cradle, it switches off automatically.

 If the gas detector remains off for longer than 21 days and is not charged, deep sleep mode is activated. In deep sleep mode, the gas detector can no longer be switched on using the Dräger CC-Vision PC software or the Dräger X-dock. In this case, the gas detector must be switched on manually.

4.5 Logging a user in or out



The gas detector has four configurable user levels. The user levels can be set using the Dräger CC-Vision PC software. User level 0 means that the user is not signed on. User levels 1 to 3 require a password for sign-on.

The following passwords are created by default:

User level 1:	0001
User level 2:	0002
User level 3:	0003

 Dräger recommends changing the predefined passwords after initial commissioning.

Default setting:

Function	User level			
	0			
Bump test	-	✓	-	-
Fresh air adjustment	✓	✓	-	-
Clearance measurement ¹⁾	✓	✓	-	-
Leak search ¹⁾	-	✓	-	-
Benzene/pre-tube measurement ¹⁾	-	✓	-	-
Settings menu	-	✓	-	-
Maintenance menu	-	✓	-	-
Change measurement gas ¹⁾²⁾	-	✓	-	-
Bluetooth ^{®1)}	✓	✓	-	-

1) X-am 8000 only

2) The data stored in the statistics counters are lost when the measurement gas is changed. The Dräger GasVision PC software can be used to manually view the data via the data logger at a later point in time. Automatic notifications via the X-dock Manager may only be available to a limited extent.

To log in a user:

1. Select  in measuring mode and confirm the dialog.
2. Select and confirm **Login**.
3. Enter the four-digit user level password and confirm each digit.

To sign out a user:

1. Select  in measuring mode and confirm the dialog.
2. Select 'Sign out' and confirm the dialog.

4.6 Preparations for operation

WARNING

Serious damage to health!

An incorrect calibration can lead to incorrect measured values, which may result in serious damage to health.

- ▶ Before performing safety measurements, check the calibration by way of a bump test, adjust as necessary, and check all alarm elements. If national regulations exist, the bump test must be performed in accordance with these regulations.

WARNING

Risk of explosion

Only applicable if using the Dräger CSE Connect app:

The use of an unsuitable smartphone or accessories may lead to ignition of flammable or explosive atmospheres.

- ▶ The smartphone on which CSE Connect is installed must be suitable and approved for use in areas subject to explosion hazards.
- ▶ A list of compatible smartphones is available from Dräger.
- ▶ Use only accessories that are suitable for use in areas subject to explosion hazards.

-
1. Switch on the gas detector. The current measured values are shown in the display.
 2. Observe warnings, error messages and special states.
 3. Verify that the gas inlet openings and membranes are clean, freely accessible, dry and undamaged.
 4. Check that the date and time are set correctly.

4.7 During operation

WARNING

Danger to life and/or risk of explosion!

The following alarms indicate a danger to life and/or risk of explosion:

- A2 alarm
 - STEL or TWA alarm
 - Device/channel error
 - ▶ Immediately leave the hazard area.
-

⚠ WARNING

Incorrect measured values!

Only for diffusion mode: If water seals the gas inlets on the gas detector (e.g. in heavy rain or if the gas detector is submerged in water), incorrect measured values may be returned.

- ▶ With the display facing downward, shake the gas detector to remove the water.
-

⚠ CAUTION

High readings outside of the LEL display range or a blocking alarm may indicate an explosive concentration.

If the concentrations of combustible materials are too high, this may be the result of a lack of O₂.

4.7.1 Monitoring measuring mode





In normal measuring mode, the measured values are displayed for every measurement gas (see Graphic E on the fold-out page). The operation signal sounds at regular interval (configurable), and the green LED pulses (e.g. visual operation signal or D-light feature).

If a measuring range is exceeded or not reached, the respective symbol is displayed instead of the measured value. For further information, see the following chapter: "Symbol explanations", page 16

If, in measuring mode, an event (e.g. an alarm) occurs, the respective symbol is displayed in the status bar (after the event is acknowledged, if necessary).

4.7.1.1 Displaying the measuring channel

To display an individual measuring channel:



1. Select  in measuring mode.
2. Use  or  to view the individual measuring channels.
3. Select  to navigate to the measuring channel overview.

4.7.1.2 Opening the event report

The following events are counted and displayed: A1/A2, STEL, shocks, incorrect password entries.

 If the gas detector is switched off and then on again, the event report is deleted.

To open the event report:

1. Select  > **Info** > **Device information** in measuring mode.
 2. Use  or  to scroll through the individual pages until the event report.
-

 The  symbol indicates a failed sign-on only after 5 attempts.

4.7.1.3 Activating the pump

To activate the pump in (normal) measuring mode:

1. Place, align and tighten the pump adapter on the thread port on the top cover. Check that the pump adapter is mounted correctly. Avoid bending the pump adapter. The gas detector automatically switches to pump mode as soon as the pump adapter is mounted.
⇒ The leak test starts automatically.
2. When the leak test is displayed, the suction inlet on the probe or hose closes within 60 s and remains closed until the leak test is complete.
3. Release the inlet opening.
 - Leak test successful: Measurement starts.
 - Leak test failed: Inspect the accessories and the pump adapter and then repeat the leak test.
4. Observe the flushing times. For further information, see the following chapter: "Special features when measuring with the pump", page 25

4.7.2 Alarms

In the event of an alarm, corresponding displays, the optical alarm, vibration alarm as well as, if necessary, the acoustic alarm are activated (configurable). For further information, see the following chapter: "Alarm settings", page 69

To acknowledge an alarm:

1. Select .

4.7.3 Special state

The operation signal is deactivated during a special state. Special states are displayed by the following visual signals:

- Yellow LED flashing – 'warm-up 1' special state
- Yellow LED continuously illuminated – general special state

No alarms are issued during a special state.

Exception: The calibration adapter is mounted in measuring mode. In this case, alarms continued to be issued as long as the measurement gas can reach the sensors.

WARNING

Incorrect measurement!

A mounted calibration adapter blocks free gas diffusion to the sensors. Correct measured values and alarms can no longer be guaranteed.

- ▶ It is imperative to actively bump the sensors (e.g. test gas cylinder with pressure reducer, flow 0.5 L/min).
-

4.7.4 Blocking alarm

The blocking alarm protects the CatEx sensor.

If the measuring range is exceeded significantly at the CatEx channel (very high concentration of flammable materials), a blocking alarm is triggered. This CatEx blocking alarm can be acknowledge by switching the gas detector off and then on again in fresh air.

X-am 8000 only: This does not apply in the case of an activated over range for methane.

4.7.5 Deleting (application) peaks

1. Select ★ in measuring mode.
2. Select **Clear app. peak** and confirm the dialog.

 The function must be activated in the quick menu. Alternatively, this function can also be called via the menu.

4.8 Calling the Quick Menu

The Dräger CC-Vision software can be used to save up to 6 preferred features.

The following features are default settings:

- Device information
- Switch between day and night mode
- Display messages
- Display shift peaks
- Display application peaks
- Delete application peaks

To open the quick menu:

1. Select ★ in measuring mode.
2. Select and confirm the desired feature.

4.9 Opening information

1. Select  > **Info** in measuring mode.

The following options are available:

Option	Description
Messages	The pending warnings and errors are displayed.
Device information	Device information and information about the Bluetooth® module (optional, X-am 8000 only) is displayed (e.g. MAC address, serial number, firmware version etc.).

Option	Description
Gas statistics	<p>The following gas statistics are available:</p> <ul style="list-style-type: none"> – Select Shift peak to display the exposure peaks for all gasses. – Select Application peak to display the application peaks for all gasses. – Select TWA values to display the available TWA values for all gasses. – Select STEL values to display the available STEL values for all gasses.
Intervals	<p>The following intervals are available:</p> <ul style="list-style-type: none"> – Select the bump test interval (Bump test interval) to display the days remaining until the next bump test for all channels. For details, select and confirm the respective channel. – Select Calibration interval to display the days remaining until the next calibration for all channels. For details, select and confirm the respective channel. – Select Life time to display the remaining life time.
Capture ranges	Capture ranges are displayed.
Battery	The battery state of charge is displayed (large).
Approvals (X-am 8000 only with the Bluetooth® module)	Approval information is displayed (e-Label).

4.10 Measuring

4.10.1 Special features when measuring with the pump

NOTICE

Magnetic media may be damaged!

The pump adapter and calibration adapter contain a magnet which may delete data from a magnetic stripe.

- ▶ Do not bring magnetic media (e.g. credit cards) into close proximity to the pump adapter or calibration adapter.
-
- Use the dust and water separators when taking measurements with the pump.
 - Following a bump test with aggressive gases (such as biogas or chlorine), flush the pump with clean air for several minutes to extend the service life of the pump.

 The wizards are only available for X-am 8000.

For the DrägerSensors XXS Cl₂, COCl₂, O₃ as well as amine and odorants, there are no wizards for confined spaces and leak searching, as these materials can not be pumped (properly) through tubes. In addition to the materials listed above, there may also be other materials for which there are no flushing times available in the gas detector. There is no confined space entry wizard for these materials.

Flush the Dräger sampling hose or Dräger probes prior to each measurement with the gas to be measured. The flushing phase is necessary to reduce negative effects associated with the use of a sampling hose or a probe, e.g. gas transport time, memory effects, dead volume. The duration of the flushing phase depends on factors such as type and concentration of the gas or vapour to be measured as well as material, length, diameter and age of the sampling hose or probe. In addition to the flushing time, the sensor response time must be observed (refer to the instructions for use for the DrägerSensors used).

Generally, when using a sampling hose (3 mm internal diameter, new, dry, clean) with standard gasses, a typical flushing time of approx. 3 s/m is required.

Example:

The flushing time for oxygen with a 10 m hose is approx. 30 seconds. The assumed sensor response time is approx. 10 seconds in addition. Thus, the overall time before reading the gas detector is approx. 40 seconds.

A flow-rate alarm is delayed by 10 to 30 seconds depending on the length of the hose.

X-am 8000: For benzene/pre-tube measurements, the maximum hose length is 10 m.

4.10.2

Carrying out measuring with the pump

Requirements:

- The gas detector is equipped with a pump and is switched on.
 - All installed sensors are warmed up.
 - The gas detector is ready to take measurements.
 - The thread port for the pump adapter and calibration adapter must be clean.
1. Connect the hose (3 mm internal diameter) with the dust and water filter to the inlet spout (see figure M on page 3) of the pump adapter.

2. Mount the pump adapter to the gas detector. Make sure that both guide pins are in the correct grooves.

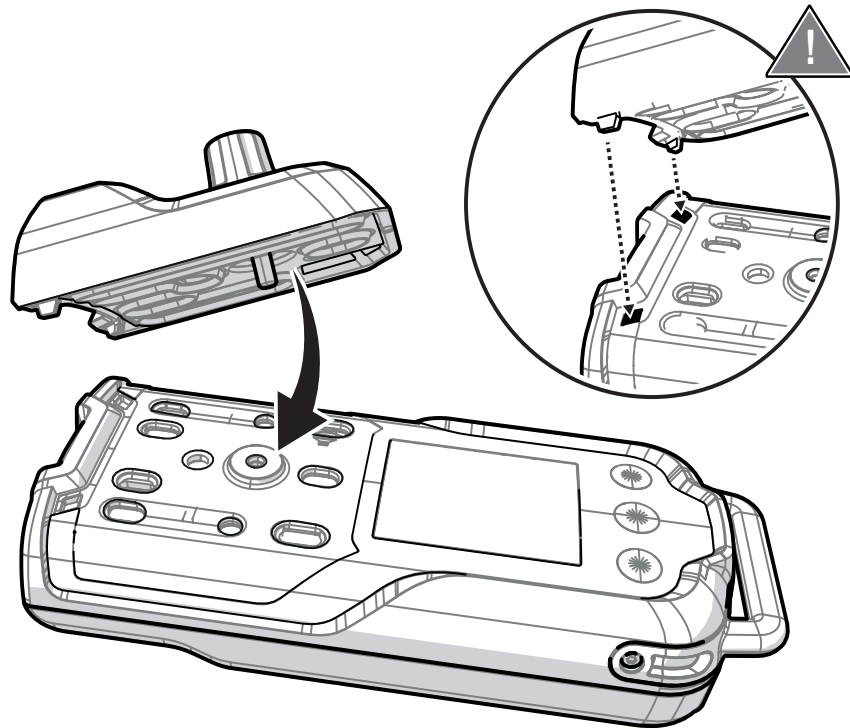

34964

i Check that the pump adapter is mounted correctly. If the pump adapter is mounted correctly, the leak test starts automatically. If the leak test does not start, the gas detector is not ready for use. Avoid bending the pump adapter.

The gas detector automatically switches to pump mode as soon as the pump adapter is mounted.

⇒ The leak test starts automatically.

3. When the leak test is displayed, the suction inlet on the probe or hose closes within 60 s and remains closed until the leak test is complete.
4. Open the suction inlet.
 - Leak test successful: Measuring starts. Observe the purging times!
 - Leak test failed: Inspect the probe, hose and adapter and repeat the leak test.
5. Place the probe or the end of the hose on the sampling location.

i The temperature at the measurement location may deviate from the temperature in the gas detector, which may influence the measured value display. The correct functioning of the temperature correction can only be guaranteed on the gas detector.

To stop measuring with the pump:

1. Loosen the screw on the pump adapter.

2. Remove the pump adapter.
- ✓ The pump is flushed and the gas detector automatically switches to diffusion mode.

4.11 Measurements with wizards

The gas detector has wizards for easily preparing the measurements and for measurement displays optimised for the measurement.

There are wizards for the following applications:

- Confined space entry: for measuring with a probe/hose, e.g. In a container
- Leak search: for detecting gas leaks
- Benzene/pre-tube measurement: for using pre-tubes as a filter for the PID

While the wizard loads, the gas detector is in a special state.

The wizards are not supported if the gas detector does not have the required material-specific properties for the gas to be measured, or if the gas detector is not within the permissible temperature range (typically 0 to 40 °C for confined spaces and benzene/pre-tube measurements).

4.12 Carrying out confined space entry measurements with the wizard

During confined space entry measurements, the duration of the measurement (in mm:ss) is displayed for a maximum of one hour in place of the time. Afterwards, the time is displayed again. The measurement duration is restarted after each flow alarm.

Requirements:

- The gas detector is switched on.
- The user is signed in with the corresponding user level.

To carry out a confined space entry measurement:

1. Sign in with the required user level, if necessary.
2. Select  > **Confined Space** in measuring mode (if configured using the Dräger CC-Vision PC software). Follow the directions of the wizard.
 - ⇒ The hose length or probe selection is displayed.
3. Select the hose length / probe.
 - ⇒ The leak test starts.
4. Confirm the successful leak test.
 - ⇒ The start dialog for the measurement is displayed.
5. Place the probe or the hose on the sampling location.
6. Confirm the dialog to start the measurement.

The hose is flushed, and the remaining flushing time is displayed. If, during the flushing time, an alarm threshold is or the permissible temperature range is exceeded, the countdown is stopped, the alarm or message is displayed and the special state is exited.

The displayed flushing time shows the minimum wait time required for the measurement gas to reach the sensor from the sampling location in an ideal scenario. This applies to the use of a Dräger sampling hose (fluoroelastomer, brand new, dry, clean) with an internal diameter of 3 mm. Other fixtures (e.g. pre-tube) extend the minimum wait time and must also be taken into consideration. The flushing time only applies to the configured measurement gas.

i The flushing times recommended by the gas detector are ascertained according to the state of technology. Dräger is not liable for their use. The user is responsible for evaluating the wait time for their application. After the wait time expires, evaluation is required to determine if the measured value is stable or if the wait time was possibly insufficient. The same applies if the countdown was stopped unexpectedly.

The measurement of other gasses or vapours than the selected measurement gas per measuring channel causes additional wait time which must also be considered in addition to the minimum wait time.

The confined space entry measurement is displayed when after the flushing time is complete.

To end the confined space entry measurement:

1. Select during the confined space entry measurement and confirm the dialog.
⇒ A dialog for performing another confined space entry measurement is displayed.
2. Select to end the wizard.
3. Remove the pump adapter.
4. Return to normal measuring mode.

4.13 Carrying out leak searches with the wizard

During a leak search, the duration of the measurement (in mm:ss) is displayed for a maximum of one hour in place of the time and the measured values can be displayed in the form of a bar chart (configurable with the CC-Vision PC software). Afterwards, the time is displayed again. The measurement duration is restarted after each flow alarm.

i During a leak search, the **Clear app. peak** feature should be stored in the quick menu using the Dräger CC-Vision PC software. This feature can be used to delete the application values in the bar chart.

i Because of the physical flushing times, Dräger recommends carrying out measurements with the leak search wizard without a hose/probe or with only a short hose (max. 2 m).

Requirements:

- The gas detector is equipped with a pump and is switched on.
- All installed sensors are warmed up.
- The gas detector is ready to take measurements.

To carry out a leak search:

1. Sign in with the required user level.
2. Select  > **Leak Search** in measuring mode.
3. Confirm the successful leak test to start the measurement.

 The device emits tones in the “Individual measuring channel” display which increase in frequency as the gas concentration increases. If the pre-alarm threshold is reached, the gas alarm appears.

To end the leak search:

1. Select  in leak search mode and confirm the dialog.
2. Remove the pump adapter.
3. Return to normal measuring mode.

4.14 Carrying out a benzene/pre-tube measurement with the wizard

 Observe the instructions for use of the respective tube!
The use of a pre-tube is only possible when using the wizard.
During the benzene/pre-tube measurement, the visual alarm, acoustic alarm, vibration alarm and alarm evaluation are deactivated.

A benzene/pre-tube measurement (photoionisation detector) with a pre-tube (e.g. benzene pre-tube) can only be done with the benzene/pre-tube wizard.

During the benzene/pre-tube measurement, the gas to be measured and the PEAK values are visible on the display. All other sensors are not evaluated.

4.14.1 Mounting the pre-tube bracket

 Fast temperature and humidity changes influence the measured signal. If temperature and humidity jumps are anticipated, Dräger recommends using a damp pre-tube for the measurement.

- 1. Mount the pump adapter to the gas detector. Make sure that both guide pins are in the correct grooves.



34964

- 2. Connect the dust and water filter (3) to the short hose piece (4) on the pump adapter (5).

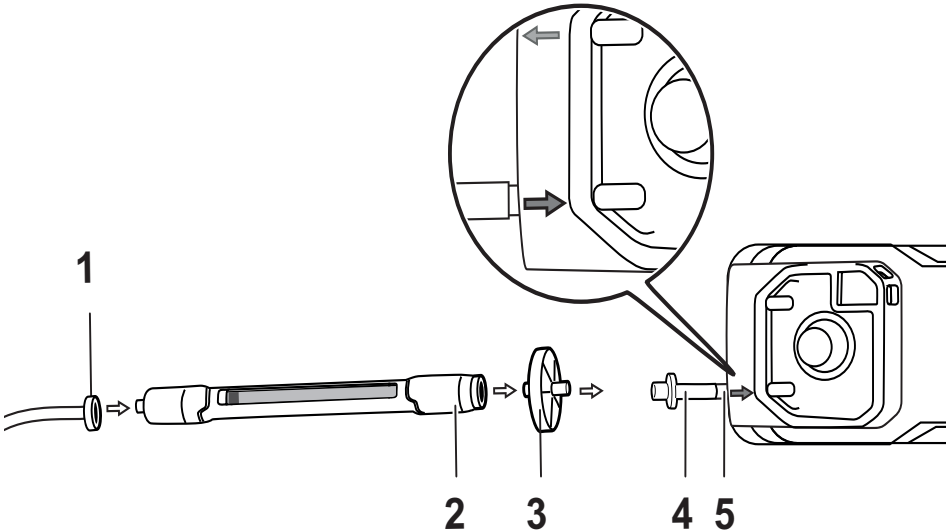

34965

- 3. Mount the pre-tube bracket (2) to the dust and water filter (3).
- 4. Mount the hose or bar probe (1) to the pre-tube bracket (2) (max. hose length: 10 m).
- 5. As necessary: Use a floating probe.

Use an adapter piece for varying hose diameters if necessary (minimum internal diameter: 3 mm).



4.14.2 Making measurement

 Use a new pre-tube for each individual measurement with a pre-tube.



Requirements:

- The gas detector is switched on.
- The user is signed in with the corresponding user level.
- Warm-up phase 1 of the PID is complete.
- The pre-tube bracket and the dust and water filter are mounted on the pump adapter.

To carry out a benzene/pre-tube measurement:

1. Select  > **Benzene / Pre-tube** in measuring mode (if configured using the Dräger CC-Vision PC software).
 - ⇒ A dialog for performing the fresh air calibration is displayed.
2. Carry out a fresh air calibration with an activated charcoal tube or skip this step by pressing .
3. When selecting the fresh air calibration:
4. Follow the directions of the wizard.
5. After a successful fresh air calibration, remove the activated charcoal tube.
6. The pre-tube selection is displayed.
7. Select the pre-tube.
 - If a benzene pre-tube is selected, the PID automatically switches to benzene.
8. Open the pre-tube, insert it in the pre-tube bracket (arrow marking in the direction of the gas detector; see figure L on page 3) and confirm the dialog.
 - ⇒ The hose length selection is displayed.
9. Select the hose length or probe.
 - ⇒ The leak test starts.
10. Confirm the successful leak test.
 - ⇒ The start dialog for the measurement is displayed.
11. Place the probe or the end of the hose on the sampling location.
12. Select  to start the measurement.
 - ⇒ The hose is flushed, and the remaining flushing time is displayed.
The benzene/pre-tube measuring mode is displayed after the flushing time is complete.

To end the benzene/pre-tube measurement:

1. Select  in benzene/pre-tube measuring mode and confirm the dialog.
 - ⇒ A dialog for removing the pre-tube appears.
2. Remove the pre-tube.
 - ⇒ A dialog for a further benzene/pre-tube measurement appears.
3. Select  to end the benzene/pre-tube measurement.
4. Remove the pump adapter with the pre-tube bracket if necessary.

4.15 Configuring the device settings

 Briefly press  and  simultaneously to navigate to **Monitoring**.

To open the device settings:

1. Select  in measuring mode and confirm the dialog.
2. Sign in with the required user level, if necessary.
3. Select and confirm **Settings**.

4.15.1 Activating day or night mode

1. Open the device settings.
2. Select and confirm **Night mode / Day mode**.

4.15.2 Changing the device language

1. Open the device settings.
2. Select **Changing language...**
3. Select and confirm the desired language.

4.15.3 Setting the date and time

1. Open the device settings.
2. Select **Date & Time**.
3. Select **Set date format** and then select and confirm the date format.
4. Select **Set date** and then set and confirm the date.
5. Select **Set time** and then set and confirm the time.

 The user must manually switch between summer and winter time.

 When using the X-dock maintenance station, automatic time synchronisation is possible.

4.15.4 Activating silent mode

Silent mode can be activated for 15 minutes on the gas detector. When silent mode is active, vibration and the horn are deactivated. Permanent deactivation is possible using the Dräger CC-Vision PC software.

Silent mode may not be permanently activated for applications according to ATEX.

4.15.5 Activating or deactivating the capture range

1. Open the device settings.
2. Select **Capture ranges**.
3. Activate or deactivate the capture range.

 Dräger recommends that you activate the capture ranges function.

4.15.6 **Activating or deactivating Bluetooth® (X-am 8000 only)**

1. Open the device settings.
2. Select **Bluetooth**.
3. Activate or deactivate Bluetooth®.

4.16 **Activating an automatic over range**

An automatic over range can only be activated for the sensors DrägerSensor CatEx 125 PR (order number 68 12 950) and CatEx 125 PR Gas (order number 68 13 080) with the measurement gas methane.

Prerequisite:

- The measuring ranges %LEL (heat of reaction) and vol. % (thermal conductions) are calibrated.
1. The automatic over range can only be activated with the Dräger CC-Vision PC software.

⚠ WARNING

Risk of explosion!

Only for CatEx sensors: The automatic over range only applies for methane in the air. Any other gas composition has an impact on the measured signal, may cause an incorrect display of the results and may cause permanent damage to the sensor.

- ▶ Only use the automatic over range to measure methane in the air.
-

When the automatic over range is activated, the device automatically switches to the vol. % range if the 100 %LEL methane range is exceeded.

When the values return to the <100 %LEL methane range, the measured value display alternates with the transitional phase indicator (circle arrow).

4.17 **Hydrogen (H₂) added signal (for IR Ex)**

The H₂ added signal can be adjusted using the Dräger CC-Vision PC software.

Requirements:

- At least one DrägerSensor XXS H₂ HC (68 12 025) is activated. H₂ is set as the measurement gas.
- An Ex channel on the DrägerSensor DUAL IR Ex/CO₂ (68 11 960) or DrägerSensor IR Ex (68 12 180) is activated.
- Both channels are set to the unit %LEL/%LEL/%LIE.
- The H₂ added signal is only possible with a DrägerSensor XXS H₂ HC and an IR Ex channel.

When the H₂ added signal is activated, the LEL gas concentrations of both selected sensors are added together and the result is shown in the display in the place of the IR Ex display.

An activated H₂ added signal is displayed with a + next to the gas name of the IR Ex sensor in the display.

Previously set alarm thresholds are maintained in order to ensure that in the presence of hydrogen (H₂) the alarm of the IR Ex Channel is triggered earlier if required.

5 Troubleshooting

If the following remedial measures are unsuccessful, contact DrägerService.

5.1 Error

Error	Cause	Remedy
<i>Life time expired</i>	Life time of the gas detector expired	Reconfigure the life time with the Dräger CC-Vision PC software.
<i>Device locked</i>	Gas detector locked by X-dock	Unlock the gas detector with X-dock or the X-dock manger.
<i>Bump test interval expired</i>	Bump test interval expired	Carry out bump test.
<i>Calibration expired</i>	Calibration interval expired	Carry out the span calibration.
<i>Hardware error</i>	An internal fault has been detected.	Switch the instrument off then on again, or remove and reconnect the battery.
<i>Pressure too low</i>	Ambient pressure below the minimum range	Check the ambient pressure and restore the device to a permissible range.
<i>Pressure too high</i>	Ambient pressure above the maximum range	
<i>2 adapters identified</i>	More than one magnetic sensor detected	Remove the faulty magnetic fields.
<i>LED failure</i>	Failed alarm element test with X-dock: Alarm lamp	Repeat the alarm element test with X-dock.
<i>Horn failure</i>	Failed alarm element test with X-dock: Alarm horn	Repeat the alarm element test with X-dock.
<i>Vibrator failure</i>	Alarm element test result with X-dock: Vibration motor faulty	Repeat the alarm element test with X-dock.
<i>Alarm test failed</i>	Alarm test with X-dock failed	Repeat the alarm test with X-dock.
<i>Battery com. error</i>	Data connection to battery interrupted. (Screws may not be tightened properly)	Re-mount the battery.
<i>Bump test failed</i>	Bump test failed	Carry out a bump test or a span calibration
<i>Zero calibration failed</i>	Zero-point calibration failed	Carry out a zero-point adjustment
<i>Span calibration failed</i>	Span calibration failed	Carry out a span calibration
<i>Capturing is on</i>	Response time test with X-dock failed	Repeat the response time test with X-dock.

Error	Cause	Remedy
Oxygen deficiency	Insufficient oxygen for the correct functionality of the CatEx sensor	Operate the gas detector in atmospheric conditions.
Value negative	Measured value in negative range	Carry out a fresh air calibration / zero-point calibration
Sensor missing	Sensor faulty or not connected	Connect sensor or check contacts
Span calibration compensation channel failed	Failed span calibration of the horizontal electrode	Carry out a span calibration for the horizontal electrode
SDS parameter error¹⁾	IR sensor error detected.	Switch the device off and then on again; exchange the IR sensor.
Sensor subsystem error¹⁾	IR sensor error detected: IR-sensor reports an error	
IR sensor peak¹⁾	IR sensor error detected: IR signal quality	Error acknowledges itself automatically if the error condition is no longer present.
Overrange after warm-up 1	Overgassing detected on CatEx sensor immediately after warm-up 1	Carry out a zero-point adjustment
CatEx contaminated	CatEx sensor poisoning	Exchange the CatEx sensor
Invalid part no.	Sensor part number invalid or not supported.	Check the sensor date (inauguration code); use the current sensor or update the firmware.
No pump installed	The pump adapter is connected, but the pump is not usable (or not available)	Remove the pump adapter from the device
Pump flow range		Contact Dräger service
Pump error		Exchange the pump
Pump flow too low		Inspect the pump adapter, hose and hose connections

1) X-am 8000 only

5.2

Warnings

Warnings	Cause	Remedy
Life time expires soon	Life time of the device expires soon	Reconfigure the life time with the Dräger CC-Vision PC software.
Bump test interval expires soon	Bump test interval expires soon	Perform bump test
Bump test interval expired	Bump test interval expired	Perform bump test

Warnings	Cause	Remedy
Calibration expires soon	Calibration interval expires soon	Carry out a span calibration
Calibration expired	Calibration interval of the (compensation)channel expired	Carry out a span calibration
Logger almost full	Data logger memory 90 % full	Read out the data memory (with the GasVision PC software) and/or delete it.
Logger full	Data logger memory 100% full	Or switch to "overwrite".
Temperature too high	Ambient temperature too high.	Reduce the ambient temperature; calibrate the sensor.
Temperature too low	Ambient temperature too low.	Increase the ambient temperature; calibrate the sensor.
Pressure too high	Pressure above the maximum range	Lower the ambient pressure
Pressure too low	Pressure below the minimum range	Increase the ambient pressure
Battery too hot	Battery sub-system too hot	Reduce the ambient temperature
Battery too cold	Battery sub-system too cold	Increase the ambient temperature
Battery com. error	Data connection to battery interrupted. (Screws may not be tightened properly)	Re-mount the battery
Peak detected¹⁾	IR sensor error detected: IR signal quality	Switch the device off and then on again; exchange the IR sensor.
Warm-up 1	Device not yet measurement-ready	Wait until warm-up time 1 is complete
Warm-up 2	The warm-up time of the sensors varies depending on the ambient conditions.	Wait until warm-up time 2 is complete (e.g. required before calibration can be carried out)
CatEx protection	CatEx sensor blocking alarm caused by overgassing	Switch the device off and then on in fresh air
Value negative	Measured value in negative range	Carry out a fresh air calibration / zero-point calibration.
Pump error		Replace the pump.

1) X-am 8000 only

6 Maintenance

⚠ WARNING

Risk of explosion!

To reduce the risk of ignition of a flammable or explosive atmosphere, observe the following:

- ▶ Do not open the gas detector in explosion-hazard areas.

⚠ WARNING

Danger to health!

Test gas may damage health if inhaled.

- ▶ Do not inhale the test gas. Observe the hazard warnings of the relevant Safety Data Sheets and the instructions for use of the gas detector! Observe the national regulations when defining calibration intervals.

6.1 Maintenance intervals

Test	Interval
Inspection and maintenance by specialists.	Every 12 months

For inspections and maintenance, see:

- EN 60079-29-2 – Guidelines for selection, installation, use and maintenance of instruments for the detection and measurement of flammable gases and oxygen
- EN 45544-4 – Electrical apparatus used for the direct detection and direct concentration measurement of toxic gases and vapours – Part 4: Guide for selection, installation, use and maintenance
- National regulations

6.2 Calibration intervals

Observe the relevant specifications in the Sensor Handbook or in the instructions for use/data sheets of the DrägerSensors installed.

Recommended calibration intervals for DrägerSensors:

DrägerSensor	Calibration interval
CatEx, O ₂ , H ₂ S, H ₂ S LC, CO LC, SO ₂ , NO ₂	Every 6 months
IR Ex/CO ₂	Every 12 months
PID HC, PID LC ppb	Depending on the application conditions, daily calibration may be necessary. The interval can be extended little-by-little to 30 days if there are no calibration deviations on consecutive inspections.
Other DrägerSensors	See the special data sheets for the respective sensors.

6.3 Perform bump test

The bump test can be performed as follows:

- Bump test with the wizard (quick bump test)
- Bump test with X-dock (quick or extended bump test)

 Dräger recommends using the extended bump test for cross calibrations (Dräger X-dock instructions for use).

 X-am 8000: If the gas detection instrument is equipped with a PID sensor, Dräger recommends not to use the Nonane tester (order no. 83 25 61) for the bump test because of the long saturation time of the PID sensor.

6.3.1 Carrying out bump tests with the wizard

 **WARNING**

Incorrect alarm behaviour!

A closed gas path causes incorrect measured values. This may cause alarms to be triggered incorrectly.

- ▶ Never close the outlet of the calibration adapter.
-

 Dräger recommends a test gas concentration of <60 %LEL for CatEx and IR sensors and a measuring range of 0 % to 100 %LEL.

For bump tests with the wizard and the X-dock, the results are saved in the device memory.

Requirements:

- A bump test can only be carried out if at least one sensor has been configured for the bump test with the Dräger CC-Vision PC software.
 - The gas detector is switched on and warm-up phase 1 is complete.
 - The thread port for the pump adapter and calibration adapter must be clean.
 - A suitable test gas cylinder is available, e.g. a test gas cylinder (order number 68 11 130) with the following mixed gas ratios: 50 ppm CO, 15 ppm H₂S, 2,5 vol. % CH₄, 18 vol. % O₂
-

 Other test gas cylinder can be added upon request.

To perform a bump test:

1. Mount the calibration adapter to the gas detector. Make sure that both guide pins are in the correct grooves.

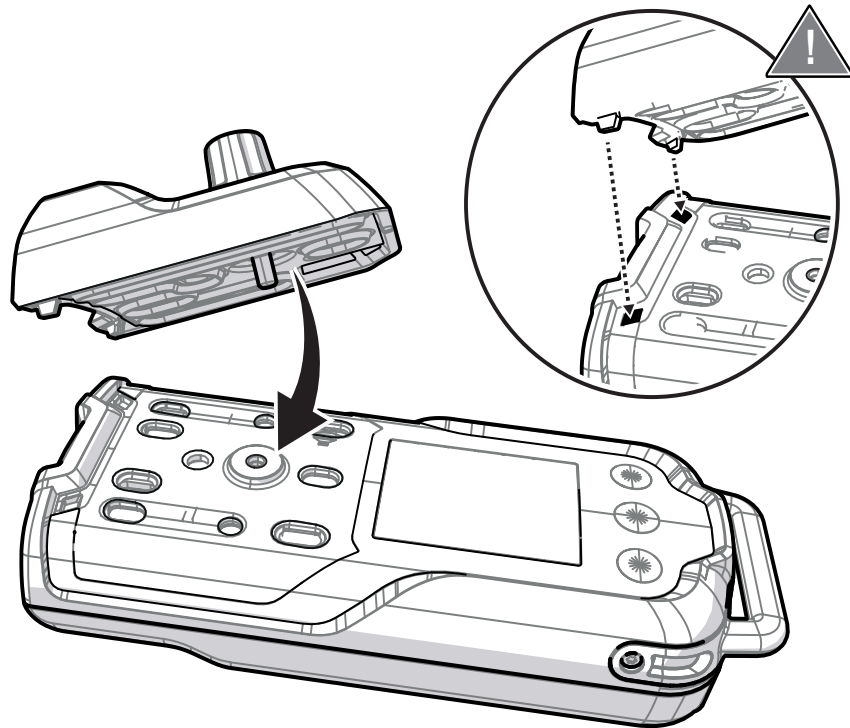

34864

2. Connect the hose to the test gas cylinder and the inlet on the calibration adapter.
3. If needed, connect a second hose (max. length: 2 m) to the outlet on the calibration adapter to direct the test gas to an exhaust or outside. Make sure that there is sufficient ventilation in room or vehicles.
4. Open the bump test (depending on the configuration).
 - a. Select > **Maintenance** > **Bump test** (if configured using the Dräger CC-Vision PC software).
 - b. > **Login**
Enter and confirm the password.
Select **Maintenance** > **Bump test**.
5. Open the valve on the test gas cylinder, the volume flow must be 0.5 /min and the gas concentration must be higher (lower with oxygen) than the alarm threshold concentration that is to be tested.
6. Select to start the bump test.

⇒ All measuring channels which are included in the bump test flash, and all others are greyed out. When a measuring channel successfully passes the test, appears.
7. The bump test is complete when all measuring channels included in the test successfully passed or failed the test.
8. Close the valves on the test gas cylinder.
 - Select and then confirm the dialog to discard the result.
 - Select to confirm the result.

9. Remove the calibration adapter.

If there was an error during the bump test:

1. An error is displayed for the measuring channel.
2. Repeat the bump test.
3. If necessary, replace the sensor.

6.4 Calibrate the gas detector

⚠ WARNING

Incorrect measured values!

An incorrect calibration may prevent alarms from triggering, or alarms may trigger late.

- ▶ Do not close the outlet of the calibration adapter / exhaust gas hose.
 - ▶ Always carry out the fresh air / zero adjustment before the span calibration.
-

NOTICE

Damage to the sensors!

When using the exhaust gas hose, the sensors may be damaged in the case of direct suction on the exhaust gas hose.

- ▶ If necessary, lead the exhaust gas hose (max. length 2 m) to an exhaust of outside.
-

Adjustment may not be possible due to instrument and channel errors.

6.4.1 Carrying out a fresh air calibration

To improve accuracy, a fresh air calibration must be carried out if there is a zero deviation.

Observe the following notices for the calibration:

- For calibrating the XXS O₂ with fresh air, set the display to 20.9 Vol%.
- There may be deviations of >10 % of the measured value for temperatures below -20 °C if the respective sensor is calibrated at room temperature. Dräger recommends calibrating the sensor at the planned operating temperature if the measurement is to be carried out at very low temperatures. This allows a possible deviation to be reduced.

X-am 8000:

- An activated H₂ added signal is automatically deactivated duration of a bump test or a calibration.
- During fresh air calibrations, the zero-point of all sensors (except the DrägerSensors XXS O₂, DUAL IR CO₂ and IR CO₂, XXS O₃) is set to 0.
- The DrägerSensors DUAL IR CO₂, IR CO₂ and XXS O₃ must be calibrated with a suitable gas which is free of carbon dioxide / ozone (e.g. N₂).
- The DrägerSensor PID LC ppb can be calibrated with the zero gasses nitrogen or synthetic air.

Requirements:

- Fresh air calibration can only be carried out if at least one sensor supports the fresh air calibration.
- The fresh air must be free of measurement or interfering gasses.
- The gas detector is switched on and warm-up phases 1 and 2 are complete.

To carry out a fresh air calibration:

1. Switch on the gas detector.
2. Open the fresh air calibration (depending on the configuration):

If the fresh air calibration was released for user level 0 by the Dräger CC-Vision PC software:

 - Select  > **Maintenance** > **Fresh air cal.**

If the fresh air calibration was not released for user level 0 by the Dräger CC-Vision PC software:

 - a.  > **Login**
 - b. Enter and confirm the password.
 - c. Select **Maintenance** > **Fresh air cal.**
3. Select to start the fresh air calibration.

⇒ All measuring channels which are included in the fresh air calibration flash, and all others are greyed out.

The result is displayed as follows for every measuring channel:

 - fresh air calibration successful.
 - fresh air calibration failed.
4. If necessary, press to overrule the stability control. In this case, a calibration happens immediately.

 Dräger recommends using the automatic stability control (wait until the gas detector has automatically carried out the calibration).

⇒ The new measured value is displayed for confirmation.

The result is displayed as follows:

- fresh air calibration successful.
- fresh air calibration failed.

5. The fresh air calibration is complete when all measuring channels included in the calibration have successfully passed or failed the calibration.
 - ▶ Select and then confirm the dialog to discard the result.
 - ▶ Select to confirm the result.

If there was an error during the fresh air calibration:

- Repeat the fresh air calibration.
- If necessary, replace the sensor.

6.4.2 Carrying out a single-gas calibration

For a single-gas calibration, you can choose either the zero-point calibration and span calibration.

With a zero-point calibration, the zero-point of the selected sensor is set to zero.

With a span calibration, the sensitivity of the selected sensor is set to the defined value of the test gas used.

 X-am 8000 only: When implementing an active over range with the CatEx sensor (measurement gas: methane), observe chapter 4.16.

Use a standard test gas.

Allowed test gas concentration:

DUAL IR Ex IR Ex	20 to 100 %LEL ¹⁾²⁾ / 5 to 100 vol % ¹⁾²⁾
DUAL IR CO ₂ IR CO ₂	0.05 to 5 Vol% ²⁾
CatEx	40 to 100 %LEL ¹⁾²⁾ 20 to 100 vol % ¹⁾²⁾
O ₂	10 to 25 vol.%
CO	20 to 999 ppm
H ₂ S	5 to 99 ppm
H ₂ HC	0.5 to 4.0 vol.%
PID HC	100 ppm iBut
PID LC ppb	5 ppm iBut

Test gas concentration of other gasses:
Refer to the Dräger CC-Vision PC software

- 1) Depending on the selected data set.
- 2) Depending on the measuring range and the measuring accuracy.

 Dräger recommends selecting a test concentration in the middle of the respective measuring range or close to the expected measuring range.

To carry out a single-gas calibration:

1. Screw the calibration adapter onto the gas detector.
2. Connect the test gas cylinder to the calibration adapter.
3. Connect a second hose (max. length: 2 m) to the second connector on the calibration adapter to direct the test gas to an exhaust or outside.
4. Switch on the gas detector.
5. Select  > **Login**.
6. Enter and confirm the password.
7. Select **Maintenance > Single gas cal.**
⇒ A dialog for selecting the measuring channel to be calibrated appears.
8. Select the measuring channel.
⇒ A dialog for selecting the calibration appears.
9. Select either zero-point calibration or span calibration.
▶ For a span calibration: Enter and confirm the calibration concentration.
10. Open the valves on the test gas cylinder.
11. Select to start the single-gas calibration or to cancel the calibration.
⇒ The measuring channel appears, and the measured value flashes.
As soon as the stability check detects a stable measured value, a calibration is carried out automatically.

12. If necessary, press to overrule the stability control. In this case, a calibration happens immediately.
- ⇒ The new measured value is displayed for confirmation.
 - The result is displayed as follows:
 - single-gas calibration successful.
 - single-gas calibration failed.
13. The single-gas calibration is complete when measuring channel successfully passed or failed the single-gas calibration.
- ▶ Select and then confirm the dialog to discard the result.
 - ▶ Select to confirm the result.
14. Close the valves on the test gas cylinder.
- If there was an error during the single-gas calibration:
- Repeat the single-gas calibration.
 - Inspect the sealing contours and surfaces on the calibration adapter as well as the front cradle of the housing to make sure they are free of damage. Inspect the thread port for the calibration adapter.
 - If necessary, replace the sensor. For further information, see the following chapter: "Exchanging, adding or removing a sensor", page 48

6.4.3 Carrying out a multi-gas calibration

All sensors which can be calibrated and are released by the Dräger CC-Vision PC software are included in the multi-gas calibration.

If no sensors are released, the multi-gas calibration menu item is not available.

With a multi-gas calibration, the sensitivity of the sensors is set to the respective concentration value of the test gas.

Requirements:

- The gas detector is switched on and warm-up phases 1 and 2 are complete. The user is signed in with the corresponding user level.
- A suitable test gas cylinder is available.
- The concentration values of the test gas cylinder are sent in the gas detector using the Dräger CC-Vision PC software.

To carry out a multi-gas calibration:

1. Select  > **Maintenance** > **Mixed gas cal.**

2. Mount the calibration adapter to the gas detector. Make sure that both guide pins are in the correct grooves.

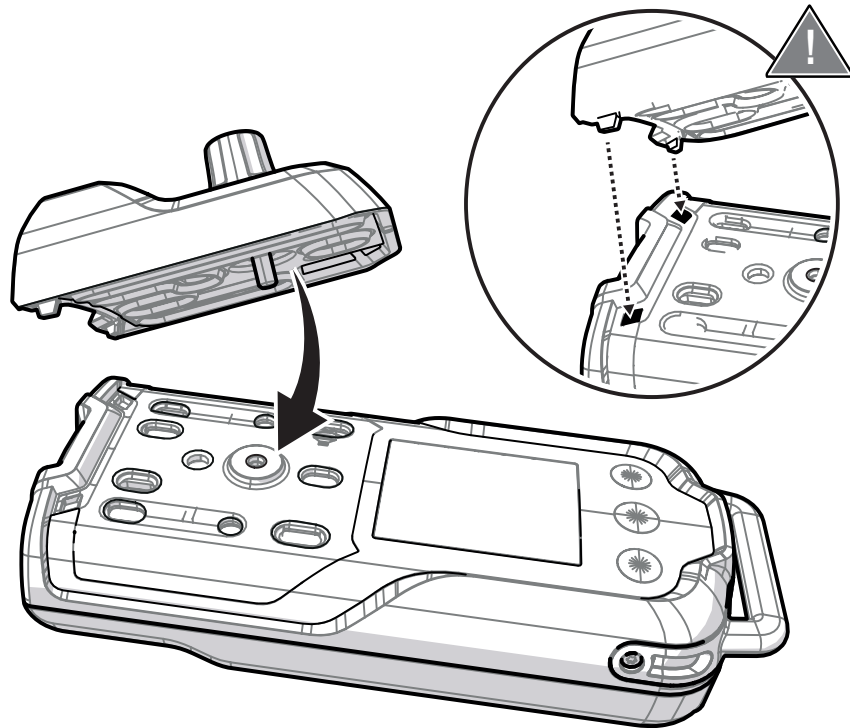

34964

3. Connect the test gas cylinder to the calibration adapter.
4. If needed, connect a second hose (max. length: 2 m) to the second outlet on the calibration adapter to direct the test gas to an exhaust or outside.
5. Open the valves on the test gas cylinder.
6. Select to start the multi-gas calibration.
 - ⇒ All measuring channels which are included in the multi-gas calibration flash, and all others are greyed out.
7. If necessary, press to override the automatic stability check. In this case, a calibration happens immediately.
 - ⇒ The new measured value is displayed for confirmation.
 - The result is displayed as follows:
 - Multi-gas calibration successful.
 - multi-gas calibration failed.
8. The multi-gas calibration is complete when all measuring channels included in the calibration successfully passed or failed the calibration.
 - ▶ Select and then confirm the dialog to discard the result.
 - ▶ Select to confirm the result.
9. Close the valves on the test gas cylinder and remove the calibration adapter.
10. Select to complete the calibration.
 - ⇒ The measured values are displayed.
11. Select to return to the menu.

If there was an error during the multi-gas calibration:

- Repeat the multi-gas calibration or carry out a single-gas calibration.
- Inspect the sealing contours and surfaces on the calibration adapter as well as the front cradle of the housing to make sure they are free of damage.
- If necessary, replace the sensor. For further information, see the following chapter: "Exchanging, adding or removing a sensor", page 48

6.4.4 Carrying out a cross calibration

If the respective gas combination and the sensor are released, an automatic cross calibration and test can be set with the Dräger CC-Vision PC software.

With the gas-switch wizard in the Dräger CC-Vision PC software, a gas can be selected for the bump test, the calibration and the measurement gas. This automatically carries out conversions, omitting the need for these to be done manually.

The settings are also used by the Dräger X-dock maintenance station.

6.5 Carrying out a signal test

In a signal test, all signalling elements are triggered for one second to test them.

To carry out a signal test:

1. Select  in measuring mode and confirm the dialog.
2. Select **Maintenance** > **Signaling test**.

6.6 Charging the battery

WARNING

Risk of explosion!

To reduce the risk of ignition of a flammable or explosive atmosphere, observe the following:

- ▶ Do not open the gas detector in explosion-hazard areas.
 - ▶ Only use the LBT 02** (lithium-ion) battery type.
 - ▶ Do not charge or exchange the battery in explosion-hazard areas.
 - ▶ Only use the battery charger specified by Dräger. The use of a different charger nullifies the explosion protection certification of the gas detector.
-

The battery is a part of the lower part of the casing. The battery can be charged with or without the gas detector.

1. Place the gas detector or only the lower part of the casing with the battery in the charging cradle.
 - ⇒ The gas detector switches off automatically. The green LED on the power pack flashes.

The typical charging time after a work shift of 8 – 10 h is approx. 4 h.

The typical charging time for an empty battery is approx. 10 h.

If the specified temperature range (5 to 35 °C) is not reached or is exceeded, charging stops automatically. This extends the charging time. After a return to the temperature range, charging continues automatically.

 The gas detector can be switched on again in the charging cradle and is then supplied with electrical current during operation.

WARNING

No measurement!

If there is an external power supply voltage drop > 1 s in the charging tray while the gas detector is in operation, the gas detector switches off.

- ▶ Ensure uninterrupted power supply. If this cannot be insured, check at regular intervals to make sure that the gas detector is switched on.

Designation and description	Order no.
Inductive charging cradle for charging 1 gas detector	83 25 825
Adapter for the plug-in power supply unit ¹⁾	83 25 736
Plug-in power supply unit for charging 1 gas detector	83 16 997
Plug-in power supply unit for charging 5 gas detectors	83 16 994
Plug-in power supply unit 100-240 V AC; 1.33 A for charging up to 5 gas detectors (requires adapter 83 25 736)	83 21 849
Plug-in power supply unit 100-240 V AC; 6.25 A for charging up to 20 gas detectors (requires adapter 83 25 736)	83 21 850
Vehicle connection 12 V / 24 V for charging 1 gas detector	45 30 057
Vehicle connection 12 V / 24 V for charging up to 5 gas detectors (requires adapter 83 25 736)	83 21 855
Vehicle mount (requires adapter 83 25 736 and vehicle connection cable 83 21 855)	83 27 636

1) Contact Dräger for availability.

6.7

Exchanging, adding or removing a sensor

 It is only possible to register sensors in the gas detection instruments X-am 3500/8000 if they are approved for the respective instrument. It is not possible to change the predefined sensor configuration for the X-am 3500.

To add a physical sensor, follow the same procedure used to exchanging a sensor. However, instead of the a sensor, there is a sensor placeholder in sensor damper. When the sensor type is exchanges, the sensor damper must also be exchanged accordingly.

When a sensor is removed from the gas detector and not replaced, a corresponding sensor placeholder (IR, CatEx, PID, EC) must be inserted in its place.

Equipment:

- Torx T8 screw driver
- Special tool for removing EC sensors
- New sensor
- Sensor damper, if required
- Sensor placeholder, if required

Designation and description	Order no.
Sensor damper set: 1x CatEx sensor damper 1x IR sensor damper 1x PID sensor damper	68 13 767
Sensor placeholder set: 1x CatEx sensor placeholder 1x IR sensor placeholder (also for PID) 1x EC sensor placeholder	83 26 818

Exchange the sensors using the Dräger CC-Vision PC program (refer to the Dräger CC-Vision online help). This tests the sensor compatibility and the respective gasses.

Procedure:

1. Connect the gas detector to a PC. For further information, see the following chapter: "Connect the gas detector to a PC.", page 66.
2. Start the sensor exchange wizard in the Dräger CC-Vision PC software and follow the instructions.
3. Open the gas detector. For further information, see the following chapter: "Opening the gas detector", page 53.
4. Remove the rear cradle of the housing with the battery.
5. Loosen 3 screws (Torx T8) on the options board.

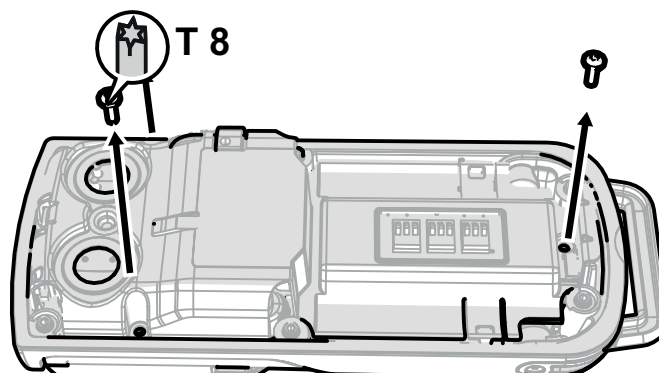

35002

6. Rotate the gas detector and carefully lift it out of the upper cradle.
7. Exchanging the EC sensors:
 - a. Remove the sensor sealing plate from the EC sensors.

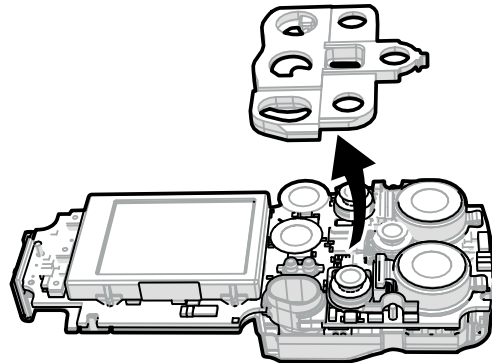

35003

- b. Place the special tool on the trough. Using the accompanying special tool (1), carefully lift out the desired EC sensor (2). Do not bend the sensor pins.

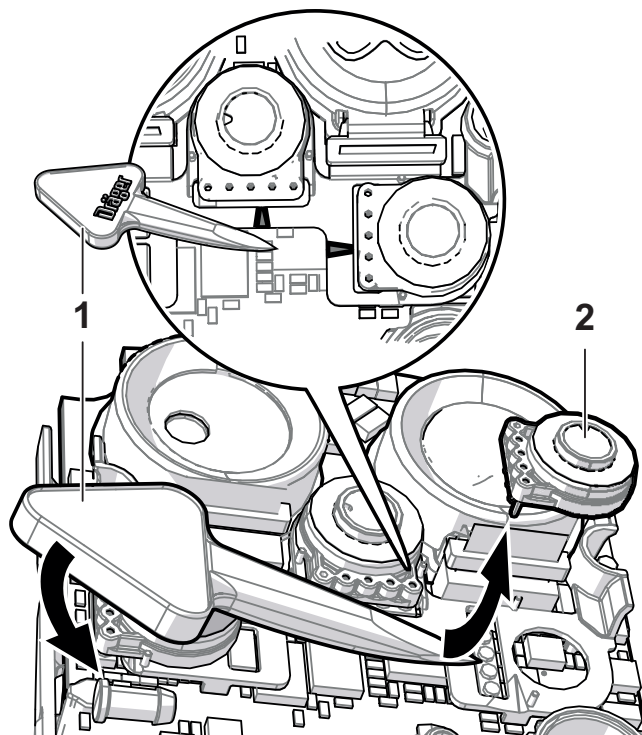

35004

- c. Only if necessary: Exchange the white sensor holder.
 - d. Have the sensor type and code (marked on the new sensor) as well as the sensor position at hand for the new sensor inauguration.

e. **⚠ WARNING****X-am 8000: Risk of incorrect measured values!**

In pump mode and after calibration, incorrect measured values may be returned if the following sensors are used on the sensor positions EC2 and EC3.

- ▶ The DrägerSensors XXS O3, XXS Cl2 and XXS COCl2 may only be used in sensor position EC1.

Carefully insert the new sensor evenly and not at an angle. Make sure that the pins are inserted in the correct positions.

- f. Place the sealing on the EC sensors.
8. Exchanging PID, CatEx and IR sensors:
 - a. Open the sensor damper.
 - b. Carefully remove the flexstrip from the options board and pull out the sensor (manually or with a removal tool (IR, PID) or with a dull instrument, e.g. Rounded side of a pair of tweezers (CatEx)).

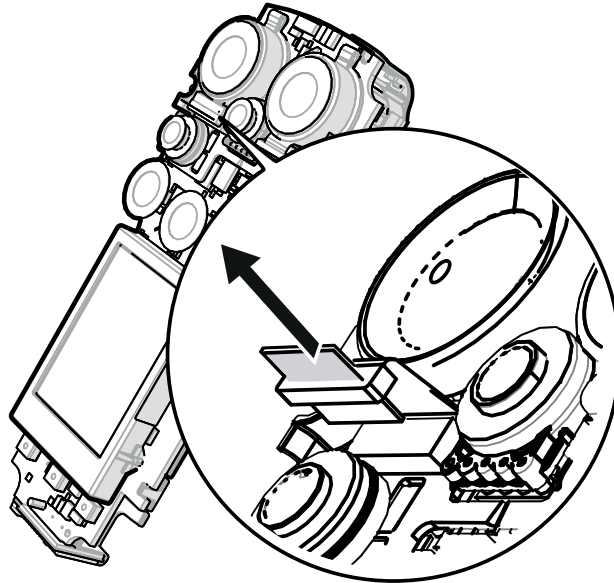

35005

- c. Have the sensor type and code (marked on the new sensor) as well as the sensor position at hand for the new sensor inauguration.
 - d. Carefully insert the new sensor.
 - e. Carefully plug the flexstrip into the bushing on the options board.
 - f. Close the sensor damper and make sure that it is positioned correctly.
9. Place the front cradle of the housing on the options board with the cover and rotate (do not angle, seals must seal properly when closed).
 10. Screw on the options board with 3 screws (60 ±5 Ncm).
 11. Reattach the rear and front housing cradles and make sure that the seals and sensor dampers are in the correct positions.
 12. Screw on the rear housing cradle with 6 screws (60 ±5 Ncm).
 13. Follow the instructions in the sensor exchange wizard in the CC-Vision PC software.

Next steps:

- ▶ After every sensor exchange, the fresh air calibration / zero-point calibration must first be carried out followed by the span calibration (multi-gas or single-gas).
- ▶ For the XXS O₂, Dräger recommends testing the alarm feature with a suitable test gas after the fresh air calibration.

6.8 Cleaning the PID lamp (X-am 8000 only)

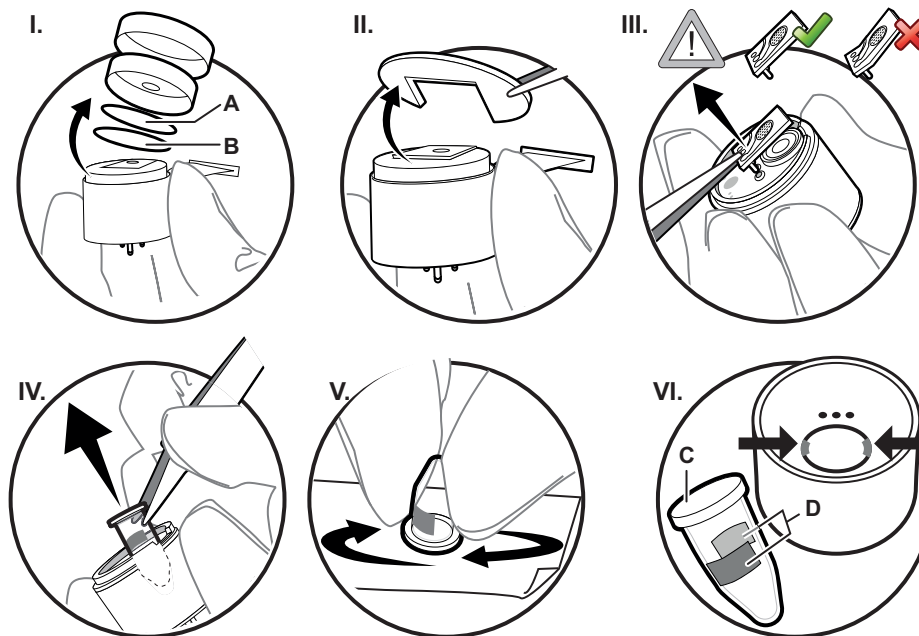

During calibration of the PID, the gas detector recognises a dirty lamp and triggers a corresponding warning. If this warning is displayed, the lamp window must be cleaned. To clean the lamp window, silicon-free single-use gloves and the DrägerSensor PID cleaning set (order number 83 19 111) must be used. The cleaning set can only be used once.

⚠ WARNING

Imprecise measured value (for PID)!

Contamination of the front lamp window (C) may negatively influence the measured value.

- ▶ Do not scratch or soil the front lamp window.

To clean the PID lamp:

1. Remove the sensor. For further information, see the following chapter: "Exchanging, adding or removing a sensor", page 48
2. Remove the stainless steel shielding cap, sensor cap and both filters (I).
3. Remove the plastic insert, e.g. by lifting it off of the edge of the sensor with tweezers (II).
4. Lift out the ionisation cell by carefully hooking the tweezers under it on the side with the contact pins and pulling it out (III). Do not bend the ionization cell.

5. Use the tweezers to remove the UV lamp. Hook the tweezers under the UV lamp and carefully angle it toward the edge of the housing to lift it out of the opening (IV).
6. Hold the UV lamp by its cylindrical shaft and place the lamp window (C) flat on the surface of the polishing paper. Polish the lamp window by applying gentle pressure to the lamp window and moving it in small circles on the polishing paper in small circles (approx. 5 to 10 seconds) (V).
7. Re-insert the UV lamp. The metal tabs (D) on the lamp must be aligned so that they touch the spring contacts in the sensor housing (VI). Gently press the UV lamp onto the lamp window in the opening. Be careful not to scratch or soil it.
8. To re-insert the ionisation cell, insert the contact pins in the opening on the sensor options board and carefully press it into place until the cell is laying flat on the lamp window. Do not bend the ionization cell.
9. Insert the plastic insert.
10. Insert a new cotton filter (B; from the PID cleaning set).
11. Insert a water protection film (A; from the PID cleaning set) with the glossy side facing up.
12. Place the sensor cap on (with the opening over the ionisation cell). The sensor cap must click into place.
13. Place the shielding cap on. The opening in the shielding cap must be over the gas inlet on the sensor cap and rest securely on the shielding body. Use the arrows markings on the shielding body for orientation.
14. Insert the sensor. For further information, see the following chapter: "Exchanging, adding or removing a sensor", page 48
15. Carry out the zero-point adjustment.
16. Carry out the span calibration.

If the warning persists after the cleaning, and the sensor cannot be calibrated, the PID must be exchanged (For further information, see the following chapter: "Exchanging, adding or removing a sensor", page 48).

6.9 Exchange the device components

WARNING

Loss of explosion protection!

Incorrect assembly or disassembly may compromise IP or explosion protection.

- ▶ Make sure that all seals are in their correct positions.
- ▶ The seals and sealing surfaces may not be damaged and must be clean.

6.9.1 Opening the gas detector

NOTICE

Data loss and damage to the gas detector!

If the housing of the gas detector is opened while the gas detector is switched on, data may be lost and the gas detector may be damaged.

- ▶ Switch off the gas detector before opening the housing.

NOTICE

Damage to components!

The gas detector contains components at risk of charging.

- ▶ Before opening the gas detector to exchange the sensor, make sure that the operator is earthed in order to prevent damage to the gas detector. For example, earthing may be ensured by an ESD workplace (electro static discharge).

1. Switch off the gas detector.
2. Loosen 6 screws (Torx T8) on the rear housing cradle.

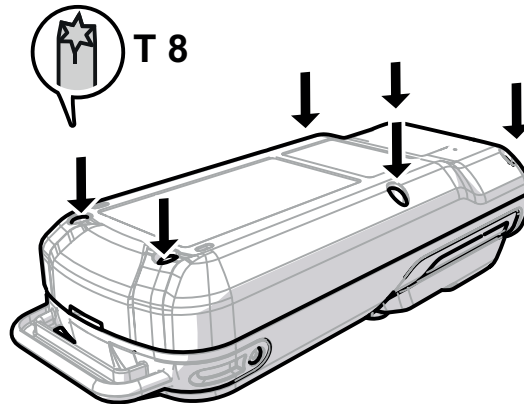

35147

3. Carefully pry apart the front and rear housing cradles (e.g. with a coin).

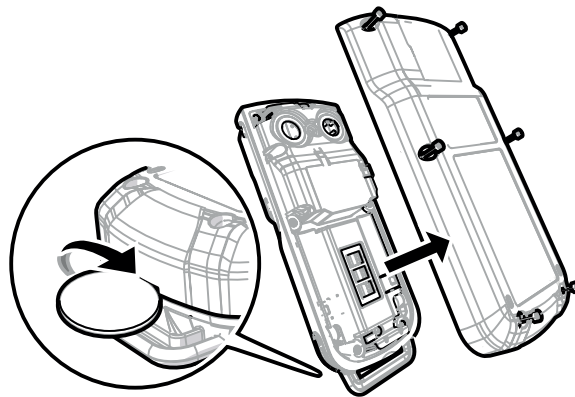

35148

NOTICE

Damage to the sealing contours!

Tools with sharp edges may damage the sealing contours.

- ▶ Do not use tools with sharp edges to remove the rear housing cradle.

6.9.2 Blind bracket / strap retainer / labelling field/label for strap

1. Remove both screws (1).

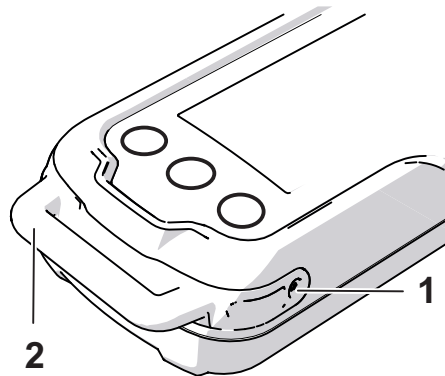

35286

2. Pull out the bracket (2) and attach the new bracket or strap retainer.
3. Insert and tighten the screws (10 - 15 Ncm).
4. Apply labelling field if necessary.

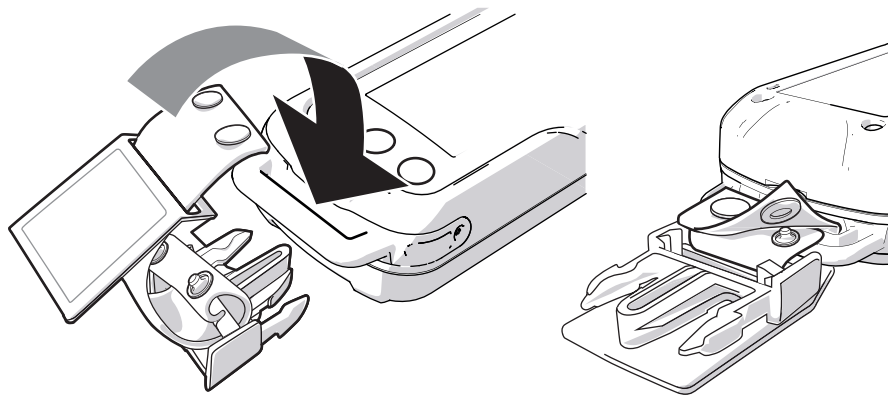

35287

6.9.3 Battery

The battery is exchanged together with the rear housing cradle.

Requirements:

- The gas detector is open.
1. Remove the rear cradle of the housing with the battery.
 2. Insert a new rear housing cradle with battery.
 3. Screw on the rear housing cradle with 6 screws.
 4. Switch on the gas detector.
 - ⇒ The wizard for setting the date and time appears automatically.
 5. Set date and time.

6.9.4 RFID transponder

Requirements:

- The gas detector is open.
- 1. Loosen 3 screws (Torx T8) on the options board.
- 2. Rotate the gas detector and carefully lift it out of the front housing cradle.
- 3. Remove the options board cover.
- 4. Detach the RFID transponder (1) from the bracket in the options board cover (top end).

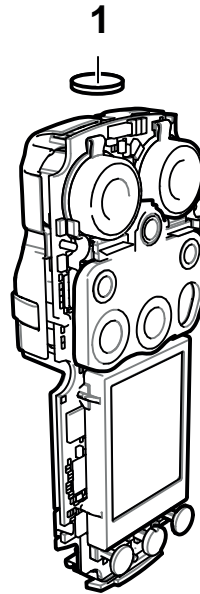

38329

- 5. Insert the new RFID transponder in the mount.
- 6. Read the ID of the RFID transponder and save it to the device using the Dräger CC-Vision PC software.

6.9.5 Front housing cradle with diaphragms

Requirements:

- The gas detector is open.
- 1. Loosen 3 screws (Torx T8) on the options board.
- 2. Rotate the gas detector and carefully lift it out of the front housing cradle.
- 3. Exchange the front housing cradle.

 The sensor and pump diaphragms can only be exchange with the upper cradle.

6.9.6 Vibration motor

Requirements:

- The gas detector is open.
- 1. Loosen 3 screws (Torx T8) on the options board.
- 2. Rotate the gas detector and carefully lift it out of the front housing cradle.

3. Remove the vibration motor (1) from the mount in the upper cradle.

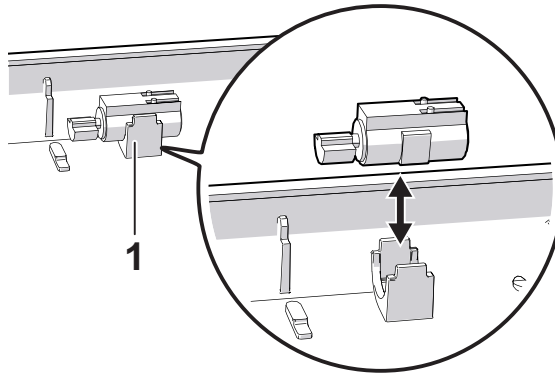

36395

4. Insert the new vibration motor in the upper cradle. Make sure that it is aligned correctly. The imbalance faces down, and the contacts face the options board.
5. Apply a drop of contact grease (order number 83 24 826) to the contacts on the vibration motor after exchanging it.

6.9.7 Sensor sealing plate

Requirements:

- The gas detector is open.

 Use the correct sensor sealing plate. The sensor sealing plate which needs to be used depends on the device configuration (with/without pump).

1. Loosen 3 screws (Torx T8) on the options board.
2. Rotate the gas detector and carefully lift it out of the front housing cradle.
3. Remove the sensor sealing plate from the EC sensors.

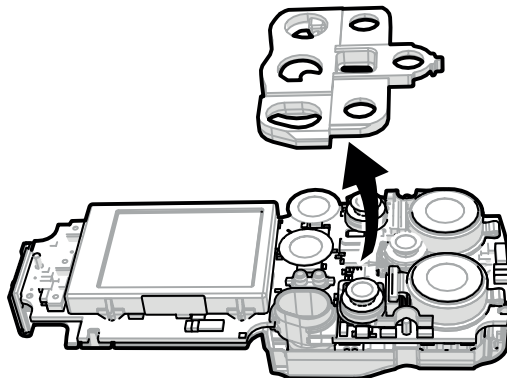

35003

4. Insert a new sensor sealing plate of the same type (press it into the double tube area (only with pump)).

6.9.8 Sensor holders

Requirements:

- The gas detector is open.
- 1. Loosen 3 screws (Torx T8) on the options board.
- 2. Rotate the gas detector and carefully lift it out of the front housing cradle.
- 3. Remove the sensor sealing plate from the EC sensors. For further information, see the following chapter: "Sensor sealing plate", page 57.
- 4. Use the accompanying special tool to carefully lift out the EC sensors (make a note of the sensor type and position for the re-assembly).
- 5. Exchange the sensor holder.
- 6. Plug the EC sensors into their original sensor slots.
- 7. Re-assemble the gas detector.

6.9.9 Pump block

Requirements:

- The gas detector is open.

 If a gas detector without a pump shall be equipped with a pump, contact Dräger service.

1. Loosen 3 screws (Torx T8) on the options board.
2. Rotate the gas detector and carefully lift it out of the front housing cradle.
3. Remove the sensor sealing plate from the EC sensors. For further information, see the following chapter: "Sensor sealing plate", page 57.

4. Remove the 3 clips from the options board cover and remove the options board.

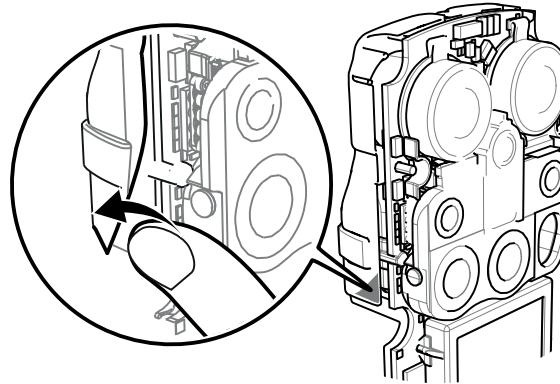

35302

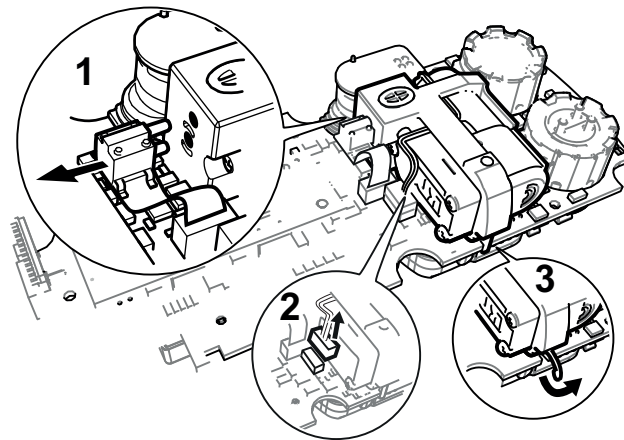

35304

5. Carefully remove the flexstrip with the differential pressure sensor (1) from the pump block.
6. Carefully remove the power connection plug (2) from the options board.
7. Remove the pump block holder (3) from the options board.
8. Pull the pump block off of the options board and pull off the double pipe.

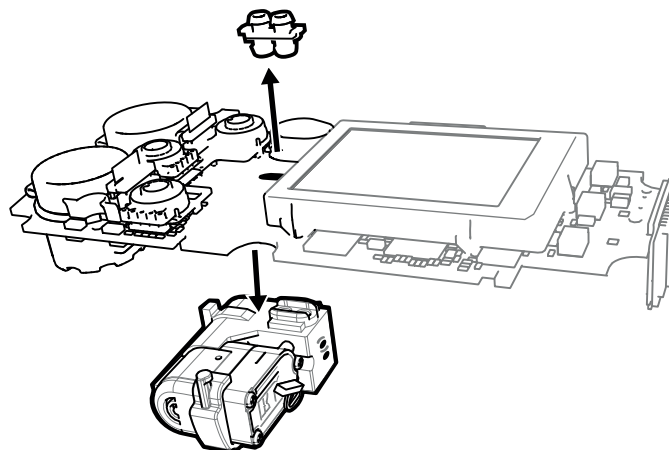

35303

9. Insert the new pump into the existing pump block and mount the entire assembly.
10. Re-assemble the gas detector. Make sure that the connector cable of the pump is running in the correct direction. The connecting cables must be routed within the space between the pump and the pump block. Observe the cable routing in figure (2).

 When assembling the options board cover, make sure that the differential pressure sensor is positioned correctly.

6.9.10

Horn / resonator

Requirements:

- The gas detector is open.
1. Loosen 3 screws (Torx T8) on the options board.
 2. Rotate the gas detector and carefully lift it out of the front housing cradle.
 3. Remove the 3 clips from the options board cover and remove the options board.

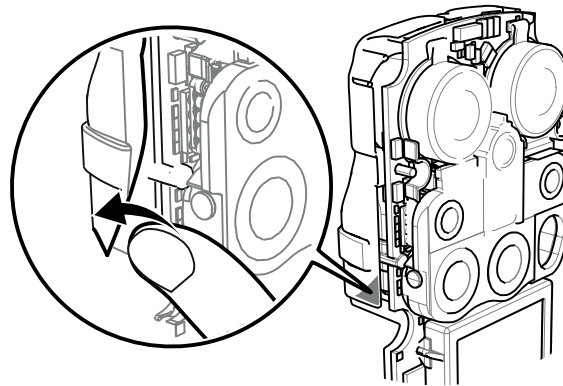

38302

4. Remove the horn (1) from the options board.

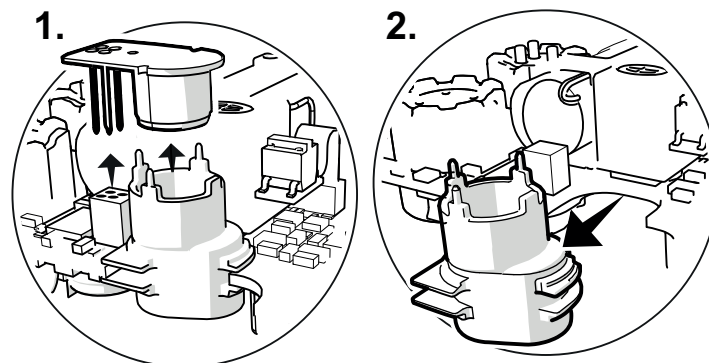

38304

5. Insert a new horn if necessary.
6. Exchange the resonator (2) if necessary.

6.10 Labelling field/label for strap

The label indicates things such as the installed sensors and other customer-specific information on the gas detector.

The label can be applied to the labelling field provided or on the strap buckle.

The labels used by Dräger (e.g. standard label, colour: silver, order number: 83 27 645) fulfil explosion protection requirements.

Labelling field dimensions:

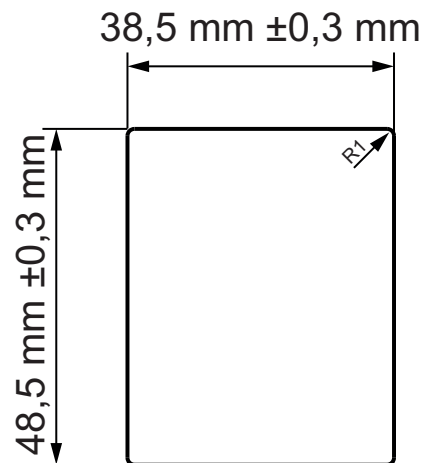

385301

⚠ WARNING

Loss of explosion protection!

Surfaces/labels may compromise the explosion protection.

- ▶ Surfaces/labels larger than 4 cm² must fulfil special explosion protection conditions (e.g. electrical conductivity).

6.11 Mounting the clip

1. Lift the rivet out of the thread on the rear housing cradle with a pointy instrument. The rivet can be reused.
2. Place the clip on the rear housing cradle and tighten the screw.

 If the clip is removed, stick the rivet in the thread for protection.

Designation and description	Order no.
Rivet set (pack of 10)	83 27 696

6.12 Radio-Frequency Identification (RFID)

Radio-Frequency Identification (RFID) uses an electronic marking mounted on a component or a system to identify devices. Every ID has an electronic transponder in a disc made of light, robust plastic. The transponder is read-only and has a

unique hexadecimal ID number which can be read by a radio reading device. The markings are passive (do not have a battery). A current source is required for signal transmission.

Intended use

Devices can be found and administrated using RFID. A radio reading device is required to read the markings (see the list of accessories). Since the type reading device is dependent on the user-specific operating conditions and applications, there is no general solution for the selection of the reading device. The markings can generally also be read when they are not located in the direct line of sight. The reading range depends on the reading device, radio interference and obstacles. Most reading devices are connected to a database containing information on the device with the marking.

⚠ WARNING

Risk of explosion!

The use of a transponder may compromise the explosion protection.

- ▶ The RFID marking may not be read in a potentially explosive atmosphere.
-

Technical data

Reading system: e.g. ASK Manchester or PSK (amplitude shift keying or phase modulation)

Operating frequency: 125 kHz

Memory: 64 bit, read-only

Bit rate: 2/4/8 kBd

Microchip: EM4102

Designation and description	Order no.
Transponder reader (125 kHz)	65 59 283

6.13

Cleaning

The gas detector does not require any special care.

If it is heavily soiled, wash the gas detector with cold water and use a sponge if necessary. Use a cloth to dry the gas detector.

NOTICE

Damage to the gas detector!

Rough cleaning objects (e.g. brushes), cleaning agents and solvent may destroy the dust and water filter.

- ▶ Only clean the gas detector with cold water and, if necessary, with a sponge.
-

7 Configuration

7.1 Standard gas configuration

Different settings can be selected to meet customer requirements on delivery. The current setting can be checked and changed with the Dräger CC-Vision PC software.

The Dräger CC-Vision PC software can be downloaded at www.draeger.com/software.

DrägerSensor	Measuring range	Alarm A1		Alarm A2			
		threshold	- ackno- wledg- eable	- latch- ing	threshold	- acknow- ledge- able	- latch- ing
DUAL IR Ex/CO ₂ : DUAL IR Ex (e.g. methane) [%LEL] DUAL IR CO ₂ [Vol%]	0 ... 100 0 ... 5	20 0.5	✓ -	- -	40 1.0	- -	✓ -
IR Ex (e.g. methane) [%LEL] IR CO ₂ [Vol%]	0 ... 100 0 ... 5	20 0.5	✓ ✓	- -	40 1.0	- -	✓ ✓
XXS O ₂ [Vol%] ¹⁾	0 ... 25	↓19.5 ↑22.5	-	✓	↓19 ↑23	-	✓
XXS O ₂ 100 [Vol%]	0 ... 100	↓18.5 ↑24	✓	-	↓17.5 ↑25	-	✓
XXS O ₂ / CO LC [Vol%]/[ppm]	0 ... 25 O ₂ 0 ... 2,000 CO	↓19 ↑23 O ₂ 30 CO	- ✓	✓ -	↓17 ↑24 O ₂ 60 CO	- -	✓ ✓
XXS O ₂ / H ₂ S LC [Vol%]/[ppm]	0 ... 25 O ₂ 0 ... 100 H ₂ S	19 O ₂ 5 H ₂ S	- ✓	✓ -	23 O ₂ 10 H ₂ S	- -	✓ ✓
XXS O ₃ [ppm]	0 ... 10	0.1	✓	-	0.2	-	✓
XXS CO LC [ppm]	0 ... 2,000	30	✓	-	60	-	✓
XXS CO HC [ppm]	0...10,000	600	✓	-	1,200	-	✓
XXS CO H ₂ CP [ppm]	0 ... 2,000	30	✓	-	60	-	✓
XXS H ₂ [ppm]	0 ... 2,000	200	✓	-	400	-	✓
XXS H ₂ HC [Vol%]	0 ... 4	0.8	✓	-	1.6	-	✓
XXS H ₂ S [ppm]	0 ... 200	5	✓	-	10	-	✓
XXS H ₂ S LC [ppm]	0 ... 100	5	✓	-	10	-	✓
XXS H ₂ S HC [ppm]	0 ... 1,000	10	✓	-	20	-	✓
XXS H ₂ S CO [ppm]	0 ... 200 H ₂ S 0 ... 2,000 CO	5 H ₂ S 30 CO	✓	-	10 H ₂ S 60 CO	-	✓
XXS H ₂ S LC / CO LC [ppm]	0 ... 100 H ₂ S 0 ... 2,000 CO	5 H ₂ S 30 CO	✓	-	10 H ₂ S 60 CO	-	✓

DrägerSensor	Measuring range	Alarm A1			Alarm A2		
		threshold	- ackno wledg eable	- latch- ing	threshold	- acknow ledge- able	- latch- ing
XXS NO [ppm]	0 ... 200	25	✓	-	50	-	✓
XXS NO ₂ [ppm]	0 ... 50	5	✓	-	10	-	✓
XXS NO ₂ LC [ppm]	0 ... 50	0.5	✓	-	1.0	-	✓
XXS SO ₂ [ppm]	0 ... 100	0.5	✓	-	1	-	✓
XXS PH ₃ [ppm]	0 ... 20	0.1	✓	-	0.2	-	✓
XXS PH ₃ HC [ppm]	0 ... 1,000	5	✓	-	10	-	✓
XXS HCN [ppm]	0 ... 50	1.9	✓	-	3.8	-	✓
XXS HCN PC [ppm]	0 ... 50	5	✓	-	10	-	✓
XXS NH ₃ [ppm]	0 ... 300	20	✓	-	40	-	✓
XXS CO ₂ [Vol%]	0 ... 5	0.5	✓	-	1	-	✓
XXS Cl ₂ [ppm]	0 ... 20	0.5	✓	-	1	-	✓
XXS OV [ppm]	0 ... 50	10	✓	-	20	-	✓
XXS OV A [ppm]	0 ... 50	10	✓	-	20	-	✓
XXS Odorant [ppm]	0...40	10	✓	-	20	-	✓
XXS Amine [ppm]	0 ...100	10	✓	-	20	-	✓
XXS COCl ₂ [ppm]	0 ... 10	0.1	✓	-	0.2	-	✓
CatEx 125 PR (e.g. methane) [%LEL]	0 ...100	20	✓	-	40	-	✓
CatEx 125 PR Gas (e.g. methane) [%LEL]	0 ...100	20	✓	-	40	-	✓
PID HC (isobutylene) [ppm]	0.3 ... 2,000	50	✓	-	100	-	✓
PID LC ppb (iso) [ppm]	0.05 ... 10	4	✓	-	8	-	✓

1) There are 4 alarm thresholds for O₂ 2 ↑ (increasing) and 2 ↓ (decreasing).

Gas configuration for PID (X-am 8000 only)

Substance	CAS no.		PID HC			PID LC ppb		
			RF ¹⁾	A1 [ppm]	A2 [ppm]	RF ¹⁾	A1 [ppm]	A2 [ppm]
Chloro benzene	108-90-7	CIBz	0.47	50	100	0.79	4	8
Acetone	67-64-1	Acet	1.04	50	100	1.17	4	8
Benzene	71-43-2	C ₆ H ₆	0.5	50	100	0.56	2	4
Cyclohexane	110-82-7	Chex	1.4	50	100	1.6	4	8
Ethyl acetate	141-78-6	Etat	4.66	50	100	4.98	10	20
Ethyl benzene	100-41-4	EtBz	0.55	50	100	0.91	4	8
Isobutylene	115-11-7	iBut	1	50	100	1	4	8
Methyl bromide	74-83-9	MeBr	1.87	50	100	2.19	10	20
Methyl ethyl ketone	78-93-3	MEK	0.9	50	100	1.05	4	8

Substance	CAS no.		PID HC			PID LC ppb		
			RF ¹⁾	A1 [ppm]	A2 [ppm]	RF ¹⁾	A1 [ppm]	A2 [ppm]
Methyl tert-butyl ether (MTBE)	1634-04-4	MTBE	0.87	50	100	1.06	4	8
n-Nonane	111-84-2	Nona	1.55	50	100	2.1	10	20
n-octane	111-65-9	Octa	1.93	50	100	2.14	10	20
Alpha-pinene	2437-95-8	aPin	0.38	50	100	0.48	2	4
Styrene	100-42-5	Styr	0.44	50	100	0.82	4	8
Toluene	108-88-3	Tolu	0.56	50	100	0.98	4	8
Trichloroethylene	79-01-6	TCE	0.53	50	100	0.95	4	8
Vinyl chloride	75-01-4	VC	1.97	50	100	2.18	10	20
o-xylene	95-47-6	Xyol	0.55	50	100	0.79	4	8
Diesel	68476-34-6	Desl	1	50	100	1	4	8
Petrol	8006-61-9	Gasol	1.21	50	100	1.21	4	8
Jet fuel	8008-20-6	JetF	1	50	100	1	4	8
1.3-butadiene	106-99-0	BTD1	0.69	50	100	0.69	2	4
1-butanol	71-36-3	BuOH	4.93	50	100	5.27	10	20
Isooctane	540-84-1	iOct	1.19	50	100	1.45	4	8
1.1-dichloroethene	75-35-4	DCE	0.85	50	100	0.76	4	8
Tetrahydrofuran	109-99-9	THF	2	50	100	1.77	10	20
Dimethylformamide	68-12-2	DMF	0.95	50	100	___2)	___2)	___2)
Cyclohexanone	108-94-1	CyHo	0.97	50	100	1.08	4	8
PID	-	PID	1	50	100	1	4	8

1) RF: Response factor at 20 °C relative to isobutylene (CAS no.: 115-11-7).

2) The measuring capability of the sensor type is not sufficient for this substance.

7.2 Configuring the gas detector

i When the capture range is deactivated, the data memory fills up with log files significantly faster, making it necessary to read it out more frequently.

i When a configuration is transmitted to the gas detector with the CC-Vision PC software, existing TWA and STEL evaluations are reset.

7.2.1 Configuring the gas detector with the Dräger X-dock and reading the data memory

To configure a gas detector with the X-dock maintenance station and read the data memory, insert the gas detector in the X-am 8000 module of the maintenance station.

Refer to the Data dongle X-dock Instruction for Use for information on how to configure the gas detector or read the data memory with the maintenance stations.

7.2.2 Configuring the gas detector with the PC and reading the data memory

7.2.2.1 Connect the gas detector to a PC.

Equipment:

- DIRA USB cable (order number 83 17 409)
- DIRA dongle mount (order number 83 25 859)

Procedure:

1. Plug the DIRA dongle mount with the dongle into the gas detector.
2. Connect the DIRA USB cable to the PC.

7.2.2.2 Configuring the gas detector with the Dräger CC-Vision PC software and reading the data memory

Requirements:

- The gas detector is connected to the PC.

To configure the gas detector using the Dräger CC-Vision PC program, refer to the Dräger CC-Vision online help.

With the Dräger CC-Vision PC software, the data logger can be downloaded as a text file.

7.2.2.3 Reading the data memory with Dräger GasVision

Requirements:

- The gas detector is connected to the PC.

The data memory is read and visually represented with the Dräger GasVision PC software (refer to the Dräger GasVision online help).

8 Device settings

Only trained and qualified personnel may change the device settings.

8.1 Factory settings

Different settings can be selected to meet customer requirements on order. The setting can be checked and changed with the X-dock maintenance station or the Dräger CC-Vision PC software.

Function	Setting
Fresh air calibration without password	On
Bump test without password	Off
Operation signal	On
Switch off allowed	On
Bluetooth® (X-am 8000 only, if installed)	Off
Capture range ¹⁾	On
LEL factor ²⁾ ch4 (methane) H2 (hydrogen)	4.4 Vol% (corresponds to 100 %LEL) 4.0 Vol% (corresponds to 100 %LEL)
STEL	STEL feature – inactive; average duration = 15 minutes
TWA	TWA feature – inactive; average duration = 8 hours
Alarm A1	Acknowledgeable; not latching, pre-alarm, increasing measured value (for O2 sensor, decreasing measured value as well)
Alarm A2	Not acknowledgeable; latching, main alarm, increasing measured value (for O2 sensor, decreasing measured value as well)
Symbol for type of danger	On
Expired bump test interval	Warning
Expired calibration interval	Channel warning
Power-save mode display	On (180 s)

1) The set capture range can be read out on the gas detector and activated or deactivated. The capture range is activated at the factory in measuring mode. The capture range is always deactivated in calibration mode.

2) An LEL factor can be adapted to national regulations using the Dräger CC-Vision PC software.

8.2 Device and sensor settings



















Name:	Area / setting
Device settings:	
Password(s)	Numerical range (4-digit)
Acoustic operation signal	Yes / No
Switch-off mode	“Switch off allowed” or “Switch off forbidden” or “Switch off forbidden in A2”
Short-term exposure limit (STEL) ¹⁾²⁾	0 - 60 (in minutes; setting for exposure alarm)
Shift length (TWA) ³⁾	60 - 1440 (in minutes; setting for exposure alarm)
Sensor settings:	
Alarm threshold A1 increasing (in measurement module)	0 to A2
Alarm threshold A2 increasing (in measurement module)	A1 to full scale deflection
Alarm threshold A1 decreasing (in measurement module, only O ₂ sensor)	A2 decreasing to A1 increasing
Alarm threshold A2 decreasing (in measurement module, only O ₂ sensor)	0 to A1 decreasing
Evaluation type ¹⁾	Inactive TWA, STEL, TWA+STEL
Alarm threshold STEL (in measurement module) ¹⁾	0 – full scale deflection
Alarm threshold TWA (in measurement module) ¹⁾	0 – full scale deflection

1) Evaluated only if the sensor is intended for this purpose.

2) Corresponds to the averaging time and is used to calculate the STEL exposure level.

3) Corresponds to the averaging time and is used to calculate the TWA exposure level.

8.3 Alarm settings

Alarms	Display	Latching	Acknowled- edgeable	LEDs	Horn	Vibration
A1 ↑ (increasing)	A1	-	✓			✓
A2 ↑ (increasing)	A2	✓	(✓) ¹⁾			✓
A1 ↓ (decreasing)	A1	-	✓			✓
A2 ↓ (decreasing)	A2	✓	(✓) ¹⁾			✓
STEL ²⁾³⁾	STEL	✓	(✓)			✓
TWA	TWA	✓	-			✓
Errors						
Battery pre-alarm ⁴⁾	-	-	✓			✓
Battery main alarm ⁵⁾	-	-	-			✓
Device error	-	✓	✓			✓
Channel error		-	✓	-	-	-

1) Acknowledgement only possible after the concentration has dropped below the alarm threshold.

2) The STEL alarm can be triggered with a delay of max. 1 minute.

3) After this alarm, the deployment of personnel is subject to the relevant national regulations.

4) The battery still lasts approx. 20 minutes after the battery pre-alarm triggers.

5) The gas detector switches off automatically 20 s after a battery main alarm.

9 Transport

The gas detector contains a lithium-ion battery. During transport, in particular air transport, of the gas detector, adhere to the relevant safety regulations and markings for lithium batteries.

10 Storage

Dräger recommends storing the gas detector in the charging cradle.

The sensors are supplied with power even when the gas detector is switched off to ensure a faster warm-up time when switching on.

When storing the gas detector outside of the charging cradle, power supply to the sensors is cut off automatically after 21 days. When the gas detector is switched on again, there is an increased warm-up time.

11 Disposal



This product must not be disposed of as household waste. This is indicated by the adjacent symbol.



You can return this product to Dräger free of charge. For information please contact the national marketing organizations or Dräger.



Batteries must not be disposed of as household waste. This is indicated by the adjacent symbol. Dispose of batteries at battery collection centers as specified by the applicable regulations.

12 Technical data

12.1 Gas detector

Ambient conditions:

during operation and storage	-20 to +50 °C 700 to 1300 hPa 10 to 90 % (briefly up to 95 %) rel. hum.
------------------------------	---

Degree of protection	IP 67 ¹⁾
Alarm volume	Typically 100 dB (A) at a distance of 30 cm
Orientation	Any
Battery	Lithium-ion battery, rechargeable, 4.8 V, 6.0 Ah, 28.8 Wh, 250 g
Dimensions	approx. 179 x 77 x 42 mm (H x W x D)
Weight (without pump)	Typically 495 g depending on which sensors are equipped, without transport harness
Weight (with pump)	Typically 550 g, depending on which sensors are equipped, without transport harness
Update interval for the display and signals	1 s
Bluetooth® range	Approx. 10 m (line of sight)
Bluetooth® range with rubber boot	Approx. 5 m (line of sight)

1) Tested without the pump or calibration adapter.

Operating time in normal conditions (diffusion mode)¹⁾:

X-am 3500/8000:	
With CatEx and 3 EC sensors	typically 24 h
With 3 EC sensors	typically 120 h
X-am 8000 only:	
With IR and 3 EC sensors	typically 22 h
With CatEx, PID and 3 EC sensors	typically 17 h
With CatEx, IR and 3 EC sensors	typically 14 h
With IR, PID and 3 EC sensors	typically 16 h
With PID	typically 42 h

1) The nominal operating time of the gas detector at an ambient temperature of 20 to 25 °C, 1013 mbar, alarms less than 1 % of the time, power-save mode display activated. The actual operating time varies depending on the ambient temperature and pressure and battery and alarm conditions.

 In pump mode: If the gas detector is used permanently in pump mode, the operating time is reduced by approx. 2 h.

This page has been left blank intentionally.

This page has been left blank intentionally.

 Manufacturer

 **Dräger Safety AG & Co. KGaA**
Revalstraße 1
D-23560 Lübeck
Germany
 +49 451 8 82-0
Fax  +49 451 8 82-2080
 www.draeger.com

90 33 665 – IfU 4836.300 en
© Dräger Safety AG & Co. KGaA
Edition: 3 – 2018-04
(Edition: 1 – 2017-06)
Subject to change

